

OIL FIRED BURNER PRODUCTS & SPARES GUIDE

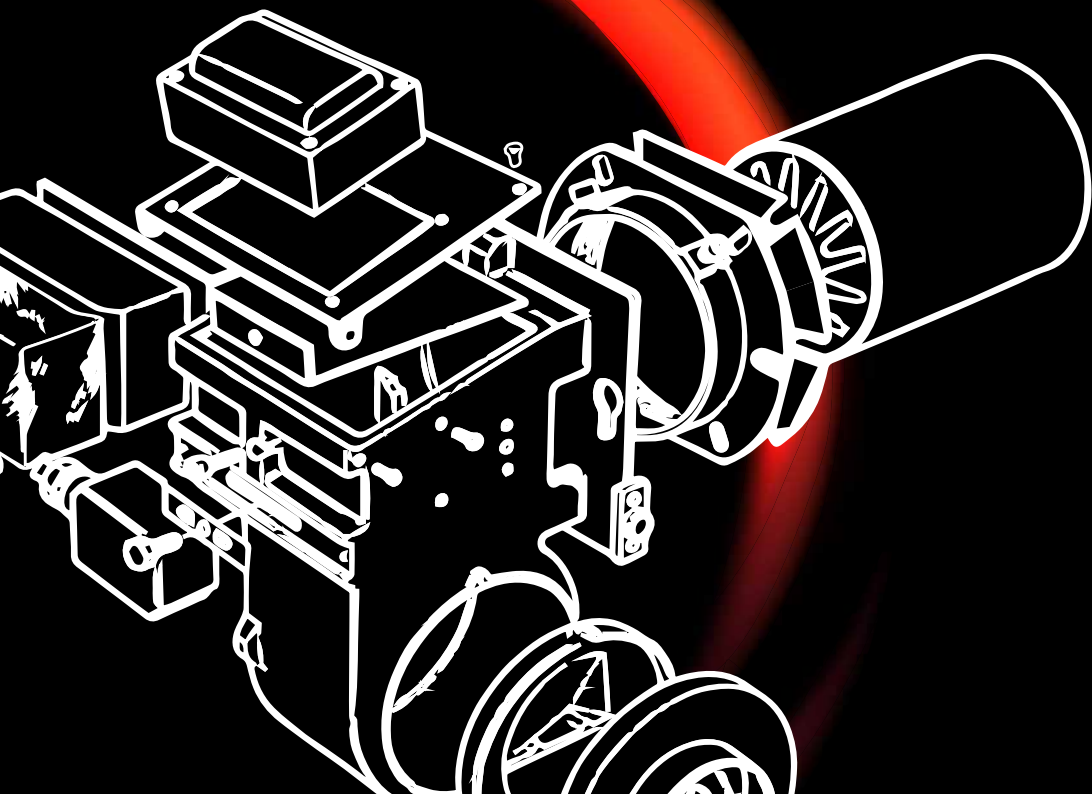

ABGO





NATIONWIDE SUPPLIER OF OIL FIRED PRODUCTS AND SPARES TO THE TRADE

ABGO

ABGO offer a nationwide mail order service supplying Oil & Gas Heating & Range Cooker spares to the trade. Our highly experienced technical sales staff are available to assist you with all of your requirements.

We provide a first class, prompt and reliable service from a wide and varied stockholding geared towards our customers' needs.

This guide has been produced to help assist the Heating Professional, and is based on manufacturers information that we believe to be accurate, however ABGO cannot accept responsibility for incorrect part selection. E & OE. Please see our Terms & Conditions of sale, available upon request.

PLEASE CALL US FOR YOUR SPECIFIC BUYING PRICES, WE GIVE OUR BEST PRICES TO HEATING ENGINEERS

The products in this guide are our normally stocked products and are the main serviceable parts which are commonly replaced, please contact us for other items in the range not shown.

We also have many other brands available, please see list below.

ABGO are committed to supporting Heating Engineers.

The pressure of modern business life can cause the little everyday courtesies to be forgotten. At ABGO, we would like you to know that we appreciate your business and thank you for giving us the opportunity of being of service.

RETURNS

In the unfortunate instance that you receive faulty or damaged goods please contact the ABGO sales office for a returns number. Please have the Invoice number to which the goods were supplied on when contacting us, with the fault that you believe to be on the component, this must be stated on the return forms in order for the manufacturer to investigate.

Goods can no longer be returned under any circumstances without ABGO returns paperwork included with returned goods. Goods ordered incorrectly must be returned within 7 days of purchase.

Handling charges will apply and the goods must be in a re-saleable condition.

We are unable to accept any unwanted Electronic/PCB goods where the security-seal has been broken.

DELIVERIES



Small Parcels - Under 1kg & fit inside express box

Excludes fragile objects, eg. glass, ceramic, insulation, radiants, coals etc

£4.50 48hr Tracked

Available until
3:30pm



Premium Parcels - Under 25kg

£8.95 Next working day ★ Free over £175 nett ★

£10.95 Before 12:00 next working day

£19.95 Before 10:30 next working day

£19.95 Saturday delivery

£25.00 Saturday before 12:00

£15.95 Offshore & Highlands (2-3 days)

Available until
5:00pm



Pallets

Rates on application

Typically from £48.00

Available until
1:00pm



CONTENTS

OIL BURNERS

RIELLO BURNERS	6	ECOFLAM BURNERS	7	NU-WAY BURNERS	8
EOGB BURNERS	9				

OIL BURNER SPARES

DANFOSS PUMPS	12-14	RIELLO PUMPS	15	SUNTEC & DELTA PUMPS	16
AIR ADJUSTMENT	17	DRIVE COUPLINGS	18-19	MOTORS	20-21
CAPACITORS	22-23	FAN WHEELS	24-25	ELECTRODES	26-27
HT LEADS	28-29	TRANSFORMERS	30	CONTROL BOXES	32-33
PHOTOCELLS	34-35	BLAST TUBES	36-38	NOZZLE HOLDERS	39
MOUNTING GASKETS	40-41	NOZZLES	42-44		

OIL SUPPLY SPARES

FLEXIBLE OIL LINES	46	NIPPLES & VALVES	47	FILTERS	48-50
SOS TANK KITS	52-53	OCV'S & SOLENOIDS	54	DE-AERATORS	55
FIRE VALVES	56-57	TANK ACCESSORIES	58-61	OIL LIFTERS	62
WATCHMAN TANK GAUGES	63	FITTINGS	64-65	OIL TANKS	66
ADDITIVES & METERS	67				

OIL BOILER SPARES

FIREBIRD	70-74	GAH	75	GRANT	76-83
WARMFLOW	84-85	TRIANCO	86-88	WORCESTER	89-93
GRANDEE	94	POTTERTON	95	HRM	96
MISTRAL	97				

OIL APPLIANCES

GRANT	100-105	FIREBIRD	106-109	FRANCO BELGE	110-111
-------	---------	----------	---------	--------------	---------

HEATING CONTROLS

COMMON CONTROLS MAP	114-115	COMMON CONTROLS	116	DRAYTON WISER	118-119
HONEYWELL SMART	120-121	WATER PUMPS	122		

TOOLS & CONSUMABLES

CLEANING EQUIPMENT	124-126	MISCELLANEOUS	127-129	SYSTEM CLEANERS	130-131
SAFETY ALARMS	132	BATTERIES	133	OIL TOOLS	134-135
HAND TOOLS	136-137	ANALYSER KITS - KANE	138	ANALYSER KITS - TPI	139
ANALYSER KITS - ANTON	140-141				



The Golf Academy

Bloxwich Golf Club

Essington

M6

M6

M6

M6

ABGO

Shortheath

Reedswood Park

Willenhall

Willenhall Rd

The Keyway

Black Country Rte

Black Country Rte

ters Ltd

IKEA

Griffiths J P Ltd

Bilston

Wednesbury



COMMERCIAL UNITS & SPARES

INDEPENDENT SITE SURVEYS AVAILABLE UPON REQUEST

ABGO
HEATING PRODUCTS & SPARES

Tony Bradburn
Commercial Sales

07971 006216

tony.bradburn@abgo.co.uk

Unit 1 Sidings Close
Wolverhampton WV11 3DR

www.abgo.co.uk

twitter.com/abgospare

COMMERCIAL, BOILERHOUSE & COMBUSTION CONTROLS



SIEMENS

Honeywell

BELIMO

BOILERS



BAXI



Glow.worm

VIESMANN

POTTERTON

WATER HEATERS

STREBEL



ANDREWS WATER HEATERS

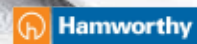



RDB NEUTRAL OIL BURNERS

The Riello RDB series of one stage light oil and kerosene burners is available in eleven basic models, with an output ranging from 16.8 to 120 kW, in three different structures.

The models are available in light oil and kerosene versions, conventional flue and balanced flue, with or without the fuel pre-heater fitted. A new model has been specifically designed to meet the increasing trends towards high pressure working field demand.



No	Model
3513008	RDB1 Neutral Burner - 16.8 - 26.3kW
3513603	RDB2 Neutral Burner - 24 - 38.3kW
3748950	RDB3 Neutral Burner - 35.6 - 68.7kW

RDB BALANCED FLUE KIT

All the RDB series models are easily converted from conventional flue to balanced flue, by replacing the plastic screen on the air intake with the connector for the air supply pipe.

No: **3062774**



R40 SINGLE STAGE OIL BURNERS

The Riello 40 G series of single stage light oil burners, is a complete range of products developed to respond to any request for home heating. The Riello 40 G series is available in eleven different models, with an output ranging from 12 to 240 kW, divided in four different structures.

All the models use the same components designed by Riello for the Riello 40 G series. The high quality level guarantees safe working.



No	Model
20030780	R40 G3B 19kW - 35kW
20030785	R40 G5 26kW - 60kW
3746467	R40 G10 54kW - 120kW
3747469	R40 G20 95kW - 213kW
3748251	R40 G20S 95kW - 240kW

ECOFLAM MAX OIL BURNERS ON/OFF TW



- New high efficiency fan ventilation system (HPV) allowing easy matching with boilers having high combustion chamber back pressure
- Sealed aluminium casing with a new modern design cover
- Compact burner dimension with low noise levels
- New air damper with progressive micrometric air regulation
- New electrical wiring simple to disassemble for easy maintenance
- Air damper with 60 or 80mm snorkel adaptor for conventional & balanced flue
- Combustion head easy to assemble and fully adjustable for fine set up
- Single bolt burner fixing and the possibility to firmly secure it to the flange in three different positions for easier maintenance
- Monoblock electrodes for easy and steady installation into the nozzle even after maintenance
- Hi-Low version available with compact hydraulic system (Max AB HS)
- Low NOx version with yellow flame developed by Ecoflam
- Max range available with "D" pump for light oil with viscosity up to 200 cTs
- Full memory & diagnostic capability

No	Model	Rate KW	Replaces
3142915	MAX 1 TC	17 - 41	Minor 1
3142710	MAX 1 TL	17 - 41	Minor 1
3142916	MAX 4 TC	20 - 59	Minor 4
3142715	MAX 4 TL	20 - 59	Minor 4
3142917	MAX 8 TC	47 - 105	Minor 8
3142717	MAX 8 TL	47 - 105	Minor 8
3142918	MAX 12TC	60 - 130	Minor 12
3142719	MAX 12 TL	60 - 130	Minor 12
3142729	MAX 15TC	73 - 190	Minor 15
3142730	MAX 15 TL	73 - 190	Minor 15
3142731	MAX 20TC	86 - 237	Minor 20
3142732	MAX 20 TL	86 -237	Minor 20
3142733	MAX 30TC	110 - 319	
3142734	MAX 30 TL	110 - 319	

DIAGNOSTIC TOOL

- Able to read burner memory
Lock outs - What they are - How long the burner has run
- Easy to read symbols - No flashing error code.
- Faults displayed such as - No Air, No Fuel, Stray Light, Low Gas
- Reads Flame signal with Burner running Gas and Oil



No: **3142931**

ST SERIES OIL BURNERS

This burner is suitable for use with both light oil and kerosene with single stage on/off operation. Available for both conventional and ducted air options and is typically suitable for domestic and commercial hot water boilers. Balanced flue available as an extra.



Key Features:

- Quick and easy installation
- Reliable and trouble free operation
- Industry standard components available

- Most components can be easily accessed allowing for easy maintenance

All Sterling burners have been designed in accordance with EN267.

No	Model
ST35 S1S 63	Sterling Light Oil Burner 14-28kW
ST40 S1S 63	Sterling Light Oil Burner 18-39kW
ST50 S1S 76	Sterling Light Oil Burner 24-66kW
ST90 S1S 80	Sterling Light Oil Burner 47-119kW
ST130 S1S 140	Sterling Light Oil Burner 59-158kW

M SERIES OIL BURNERS

This burner is typically suited for commercial hot water boiler and steam boiler systems.

Available for use with light oil Class D fuel with:

- Single stage on/off
- 2 stage high/low

Key Features:

- Quick and easy installation
- Reliable and trouble free operation
- Industry standard components available
- Most components can be easily accessed allowing for easy maintenance



No	Model
MOL 200 S1L 187	71 - 202 kW Oil On/Off 1 Phase
MOL 200 T1L 174 2H	53 - 178 kW Oil High Low 1 Phase
MOL 350 S1L 172	107 - 350 kW Oil High Low 1 Phase
MOL 350 T1L 172 2H	95 - 350 kW Oil High Low 1 Phase

X SERIES OIL BURNER RANGE

The X Series oil burner range is the latest from EOGB, a company renowned for high quality, technical excellence and environmentally safe products.

Three models, with outputs ranging from 14-100kW, can be configured for conventional or ducted air inlets to suit installations in domestic, commercial and light industrial premises.

Suitable for use with Kerosene, Gas Oil and FAME based Bio Fuel blends up to B10 as standard. B30 spec can be supplied under special order.



No: **X400** 14-36 kW
 No: **X500** 34-62 kW
 No: **X600** 50-100 kW

BALTUR COMMERCIAL OIL BURNER RANGE

TECHNICAL AND FUNCTIONAL CHARACTERISTICS

- Single stage operation (on/off)
- High pressure mechanical atomisation of fuel using nozzle
- Ability to obtain optimal combustion values by regulating combustion air and blast-pipe
- Maintenance facilitated by the fact that the atomisation unit can be removed without having to remove the burner from the boiler
- Manual air flow adjustment
- When using biodiesel light oil (fuel vegetable origin), the burner must be built with specific components: flexible hoses, line filter and pump.
- Equipped with one 7-pole connector, one flange and one insulating seal for boiler fastening, 2 flexible hoses, one line filter and one nozzle
- On request: longer blast tube, operation on biodiesel

Suitable for use with Gas oil, plus FAME based Bio Fuel blends up to B10 as standard. RME Bio fuels require Heavy Oil Burner specification. Burners suitable for higher blends are available.



No: **BTL10** / 1 Stage
 No: **BTL10** / 2 Stage
 No: **BTL14** / 1 Stage
 No: **BTL14** / 2 Stage
 No: **BTL20** / 1 Stage
 No: **BTL20** / 2 Stage
 No: **BTL26** / 1 Stage
 No: **BTL26** / 2 Stage

Built for the future. **Ready now.**



- Leading burner technology for over 90 years.
- Meeting the climate challenges of today and tomorrow.
- Maximising Efficiency and Minimising Emissions.
- The “No.1” choice for Specifiers.
- An extensive range to cover 10kW to 30,000kW.



RDB **C&I**
INSIDE **COMMERCIAL &
INDUSTRIAL**

Visit rielloburners.co.uk to find out
more or phone on 01480 432144

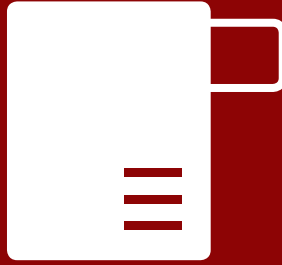

Oil Burner Spares

BFP11-L3 PUMP

L/H Rotation
7-15 bar

No: **071N7141**



BFP11-R3 PUMP

R/H Rotation
7-15 bar

No: **071N7155**



BFP20-L3 PUMP

L/H Rotation
7-20 bar

No: **071N7168**



BFP20-R3 PUMP

R/H Rotation
7-20 bar

No: **071N7169**



BFP21-L3 PUMP

L/H Rotation
7-20 bar

No: **071N7156**



BFP21-R3 PUMP

R/H Rotation
7-20 bar

No: **071N7157**



BFP41-L3 PUMP

L/H Rotation
7-20 bar

No: **071N8213**



BFP10-R3

R/H Rotation

No: **071N7253**



BFP52E-L3 PUMP

L/H Rotation
Twin coil
24 litres/hour

No: **071N3201**



BFP52E-L5 PUMP

L/H Rotation
Twin coil
42 litres/hour

No: **071N3202**



Solve your challenges
with a diamond



10 times

longer lifetime in
critical applications
e.g. in heavy loaded
conditions



Longer lifetime in heavy loaded conditions

Over the last few years oil burner applications have changed to be operated at higher pressures and with more insulation partly for noise reduction as well for energy savings resulting in harder working conditions for the pumps. This is why we have upgraded all service pumps to version 2.0 to meet the highest demands in the market.

Extra durable Diamond coil

The new extra durable Diamond Coils endure more than 5 times as many cycles in the crash test compared to previous service coils. The result has been proved in an extremely harsh crash setup demonstrating how Diamond Coils provide outstanding durability in heavy loaded conditions.



BFP DIAMOND COIL

Replaces standard coils.
220/240V



No: **071N1006**

BFP DIAMOND TWIN COIL

For BFP52 pumps



No: **071N1007**

BFP PUMP LEAD

300mm



No: **071G0205**

BFP ARMATURE



No: **071N0050**

BFP FLANGE



No: **071N0047**

PUMP GAUGE CONNECTOR



Connector No: **3008876**
'O' Ring No: **3007177**

BFP RED CARTRIDGE FILTER



No: **071N0064**

BFP DISC FILTER



No: **071N0063**

BFP BYPASS SCREW

BFP 20 / 21 / 41 / 52E
1 Pipe = Out
2 Pipe = In



No: **071N0041**

DANFOSS PUMP SERVICE TOOL



No: **DANFTOOL**

MECTRON PUMP

Suitable for
G2, G3, G5, G10
R40 burners



No: **020031996**

RDB PUMP

Suitable for
all Riello RDB
burners



No: **020030953**

MECTRON PUMP COIL



No: **3002279**

RDB PUMP COIL



Coil No: **3008648**
Lead No: **3008648**

MECTRON PUMP ARMATURE



No: **3020437**

RDB PUMP ARMATURE



No: **3007871**

RIELLO PUMP SERVICE KIT



No: **3000439**

RIELLO PUMP 'O' RING



No: **3007175**

RIELLO BYPASS SCREW

1 Pipe = Out
2 Pipe = In



No: **20029299**

RDB FILTER & SEAL



No: **3020436**

PUMP 32mm HUB

ACPE Rotation



No: **AS47C1582**

PUMP 54mm HUB

ACPE Rotation



No: **AS47C7451**

PUMP 32mm HUB

CPE Rotation



No: **AS47A7564**

SUNTEC COILS

240V
No: **ASCOIL240V**

110V
No: **ASCOIL110V**



HUB



No: **ASHUB**

FLANGE



No: **ASFLANGE**

LEAD

Suntec
pump lead



No: **ASLEAD**

ARMATURE, COIL & LEAD

No: **ASSOLENOID**



DELTA VU PUMP 230V

Delta
Universal



No: **3700100**

DELTA PUMP COIL

Delta



No: **1805999**

RIELLO SHORT AIR RAM



No: **3006911**

RIELLO LONG AIR RAM

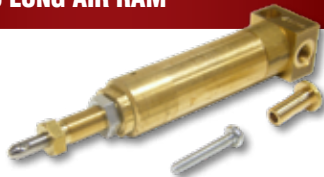

No: **3020444**

RIELLO HYDRAULIC RAM SEAL



No: **3007132**

BENTONE B9 AIR INTAKE ASSEMBLY



Intake No: **B03-00-117-58501**
Gasket No: **B03-00-118-54401**

BENTONE B11 AIR DIAL



No: **B03-00-117-28001**

BENTONE B11 AIR FLAP



No: **B03-00-115-92901**

STERLING AIR ADJUSTMENT SCREW



No: **B03-00-120-70901**

MINOR 1 AIR INTAKE



No: **GRCA020**

MINOR 4 AIR INTAKE



No: **GRCA021**

MINOR 1 SNORKEL



No: **GRCA030**

STERLING 30-50 THREE PIECE COUPLING

8mm → 8mm shaft
Length 80mm



No: **B03-00-114-07210**

STANLEY THREE PIECE COUPLING

8mm → 13mm shaft



No: **SY0100261527**

INTER 99 SMALL FLEXI DRIVE ROD

20mm Econo



No: **C01-00-114-01009**

ELECTRO-OIL PUMP COUPLING

20mm Econo → 8mm shaft



No: **C01-00-113-98202**

RIELLO R40 DRIVE COUPLING

Shaft diameter 8mm



No: **3000443**

WHITE COUPLING

Shaft diameter 11mm



No: **1209216**

ONE STEP COUPLING

Shaft diameter 8mm



No: **1209219**

ONE STEP COUPLING WITH LIP

Shaft diameter 8mm



No: **C01-0005**

TWO STEP COUPLING

Shaft diameter 8mm



No: **MP504**

TWO STEP COUPLING WITH LIP

Shaft diameter 8mm



No: **C01-0004**

ECONO ROD

Length 1 Metre
 1" Econo
 Used with the pieces
 below to create drive
 couplings

No: **1701009**

**ECONO DRIVE 8mm**

1" Econo → 8mm shaft



No: **1701001**

ECONO DRIVE 11mm

1" Econo → 11mm shaft



No: **1701003**

ECONO DRIVE 12.7mm

1" Econo → 12.7mm shaft



No: **1701005**

ECONO DRIVE FOUR SPLINE

1" Econo → 4 Spline



No: **1701008**

SIMEL MOTOR FLANGE

PCD 130mm
 Shoulder 110mm



No: **1209222**

SIMEL MOTOR FLANGE

PCD 172mm
 Shoulder 140mm



No: **1209221**

MOTOR BEARINGS

Simel No: **BS6201ZE**
 Riello No: **BS03040**

**MOTOR LEAD**

Three Pin



No: **E1109/2**

B9 BURNER MOTOR

Bentone Authorised
Shaft 8mm
70W



No: **BN11852402**

B11 BURNER MOTOR

Hanning
Shaft 8mm
90W



No: **BN12090101**

STERLING 90/146 BURNER MOTOR

Hanning
Shaft 8mm
125W



No: **BN12090001**

2011, 2010, 2020 BURNER MOTOR

AACO
Shaft 8mm
90W



No: **M02-1-90-13**

STERLING 35, 40, 50 BURNER MOTOR

AACO
Shaft 8mm
90W



No: **M02-1-90-16**

EOGB X400 BURNER MOTOR

AACO
Shaft 8mm
90W



No: **M02-1-90-18**

INTER 10 11 12 989 & 109 BURNER MOTOR

AACO
Shaft 8mm
90W



No: **M02-1-90-12**

INTER 10/109/99+D42 BURNER MOTOR

Simel
Shaft 8mm
90W



No: **A02-037R**

RIELLO RDB MOTOR

Riello
Shaft 13mm
90W



Old No: **3002836**
New No: **20071577**

RIELLO MECTRON BURNER MOTOR

Riello
Shaft 13mm
90W



No: **3007971**

Motor accessories included are correct at time of printing, but subject to change at any time. E & O.E

RIELLO G20/G20S BURNER MOTOR

Riello
Shaft 13mm
150W



No: **3005820**

RIELLO RDB4 BURNER MOTOR

Riello
Shaft 13mm
130W



No: **3008964**

MINOR 1-4 BURNER MOTOR

Simel
Shaft 13mm
70W



No: **1109024**

MINOR 1-4 BURNER MOTOR

Simel
Shaft 13mm
75W



No: **1109006**

MINOR 8 BURNER MOTOR

Simel
Shaft 13mm
100W



No: **1109007**

MINOR 12 BURNER MOTOR

Simel
Shaft 13mm
130W



No: **1109008**

MINOR 1-4 STANLEY BURNER MOTOR

Simel
Shaft 13mm
70W



No: **1109020**

ECOFLAM MAX 1 BURNER MOTOR

Simel
Shaft 13mm
75W



No: **M181/12**

ECOFLAM MAX 4 BURNER MOTOR

Simel
Shaft 13mm
90W



No: **M181/21**

ECOFLAM MAX 12 BURNER MOTOR

Simel
Shaft 13mm
130W



No: **M181/32**

Motor accessories included are correct at time of printing, but subject to change at any time. E & O.E

STERLING B9 CAPACITOR

Thin Spade
3uf



No: **B03-00-120-93301**

STERLING B11 CAPACITOR

Thin Spade
4uf



No: **B03-00-115-96501**

SIMEL CAPACITOR

3.5uf



No: **1290000**

SIMEL CAPACITOR

4uf



No: **1290001**

RIELLO RDB CAPACITOR

4uf



No: **20087035**

RIELLO RDB CAPACITOR

4.5uf



No: **20071576**

RIELLO RDB CAPACITOR

5uf



No: **20081251**

RIELLO MECTRON CAPACITOR

4uf



No: **20087025**

RIELLO G20, RLS/28/38/50 CAPACITOR

5uf



No: **20087027**

ECOFLAM CAPACITOR

2uf
50W motors



No: **C107**

ECOFLAM 480K MXE CAPACITOR

6.3uf
Suitable for
Rayburn
M181/32



No: **C107/12**

ECOFLAM MAX 1-4 CAPACITOR

3uf
Max 1-4



No: **C107/9**

ECOFLAM MINOR 12 CAPACITOR

6.3uf
130W motors
Minor 12



No: **C107/3**

ECOFLAM MAX 8 CAPACITOR

4uf
Max 8



No: **C107/10**

ECOFLAM MINOR 12 CAPACITOR

5uf
Minor 12



No: **C106/3**

ECOFLAM MAX 12 CAPACITOR

5uf
Max 12



No: **65325038**

INTER CAPACITOR

5uf
Fits A02-037R
motor



No: **BN11596502**

UNIVERSAL CAPACITOR

3uf



No: **RM3MFD**

UNIVERSAL CAPACITOR

4uf



No: **RM4MFD**

UNIVERSAL CAPACITOR

5uf



No: **RM5MFD**

B9B

Diameter 97mm
Thickness 33mm
Shaft 8mm



No: **B03-00-117-56601**

B11 2011

Diameter 108mm
Thickness 41mm
Shaft 8mm



No: **B03-00-115-92701**

STERLING ST35

Diameter 97mm
Thickness 41mm
Shaft 8mm



No: **B03-00-114-17603**

STERLING ST40

Diameter 108mm
Thickness 41mm
Shaft 8mm



No: **B03-00-114-17604**

STERLING ST50

Diameter 120mm
Thickness 42mm
Shaft 8mm



No: **B03-00-114-17601**

ST146

Diameter 146mm
Thickness 51mm
Shaft 8mm



No: **BN11872601**

PUNKER BOXER FAN

Diameter 108mm
Thickness 62mm
Shaft 8mm



No: **D04-006S**

PUNKER

Diameter 133mm
Thickness 62mm
Shaft 8mm



No: **D05-010S**

NU-WAY WRAC-632800161

Diameter 158mm
Thickness 73mm
Shaft 13mm



No: **D06-001X**

B20

Diameter 133mm
Thickness 51mm
Shaft 8mm



No: **B03-00-117-27601**

MINOR 1

Diameter 99mm
Thickness 43mm
Shaft 13mm



No: **BFV10001/001**

MINOR 1

Diameter 99mm
Thickness 34mm
Shaft 13mm



No: **BFV10003/001**

MINOR 4

Diameter 120mm
Thickness 60mm
Shaft 13mm



No: **BFV10053/001**

MINOR 8 12

Diameter 124mm
Thickness 59mm
Shaft 13mm



No: **BFV10055/001**

MAX GAS

Diameter 120mm
Thickness 50mm
Shaft 13mm



No: **BFV10060/001**

INTER 10 99

Diameter 108mm
Thickness 42mm
Shaft 8mm



No: **B03-0015**

RIELLO R40 G2 G3 G5 FAN WHEEL

Diameter 108mm
Thickness 41mm
Shaft 13mm



No: **3005708**

RIELLO G10 FAN WHEEL

Diameter 120mm
Thickness 51mm
Shaft 13mm



No: **3005788**

RIELLO G20 FAN WHEEL

Diameter 140mm
Thickness 62mm
Shaft 13mm



No: **3005799**

B9, 2011, STERLING 30, 40 & 50 B20B

Sold individually



No: **B03-00-115-93701**

STERLING BLOCK KIT 35,40 & 50



No: **B03-00-118-86701**

STERLING 90 & 130



No: **B03-00-119-24301**

INTER B30 20/40



No: **B03-00-119-24401**

EOGB 200MM



No: **E01-0001**

EOGB 275MM



No: **E01-0002**

D11-A36 & D11-F55



No: **G05-0045**

INTER 10, 12 99 & 109 PAIR



No: **B03-94-390-81815**

D13, D16, D18 & D22



No: **G05-0068**

RAYBURN 400 SERIES NUWAY



No: **R2625**

MINOR 1-8 BLOCK

Ecoflam



No: **BFE01102**

MINOR 1-8 KIT

Ecoflam
Kit to replace
x2 singles



No: **GREL007**

MINOR 12, 20 & 30 BLOCK

Ecoflam



No: **BFE01103**

MINOR 12, 20 & 30 SINGLES

Ecoflam
Sold individually



No: **GREL002**

RIELLO G3 R40 BLOCK



No: **3005721**

RIELLO G5 R40



No: **3005711**

RIELLO RDB 1 & 3



No: **3007513**

RIELLO RDB 2



No: **3008860**

RIELLO RDB 3.2



No: **3020121**

GP ANGLED ELECTRODE

360K PJ GP



No: **R1458**

EBI ACCESSORY KIT

2x secondary cables
with Ø4 plugs
2x Ø44mm plugs
2x Ø6.35 mm plugs



No: **052F0061**

INTER B20 IGNITION LEADS

Length 300mm



No: **B03-00-120-67830**

STERLING 35 40 50 90 130 IGNITION LEADS

Length 300mm
For standard
length tubes.



No: **B03-00-120-67930**

B11 IGNITION LEAD

Length 400mm



No: **B03-00-120-68020**

EOGB X SERIES IGNITION CABLE

Length 370mm



No: **E80-0601**

INTER TRANSFORMER LEAD

Length 750mm



No: **F04PATB7505**

MINOR 1 HT LEAD

Length 235mm



No: **BFE01401/1**

MINOR 4-8-12 HT LEAD

Length 325mm



No: **BFE01401/2**

MINOR 8-12 HT LEAD

Length 425mm



No: **BFE01401/4**

UNIVERSAL HT LEAD

Length 350mm
2.8mm Flat spade
connections



350mm No: **3153001**

1000mm No: **3153005**

RIELLO HT LEAD

Length 600mm



No: **3012393**

RIELLO HT LEAD

Length 170mm



No: **3008794**

UNSHROUDED RAJAH CONNECTION



No: **3600100**

SEMI SHROUDED RAJAH CONNECTION



No: **3600103**

FULLY SHROUDED RAJAH CONNECTION



No: **3600105**

IGNITION LEAD MULTI-KIT

1500mm lead & accessories



No: **REG-C30**

XGN GREEN 4 PIN BURNER PLUG



Male No: **B08-052J**
Female No: **B08-046L**

WEILAND 7 PIN BURNER PLUG



Male No: **B08-049X**
Female No: **B08-047M**

MULTIFUNCTION LOOP TESTER WITH TEST LEAD KIT

Multi-Function electrical checker designed specifically for checking heating appliances.
4 in 1 RCD tester - loop, mains voltage, correct wiring and correct polarity.
Carry case and manual included.

No: **REG-XP5**



DANFOSS EBI4

Twin Outlet
c/w Lead



No: **052F4064**

FIDA EBI4

Twin Outlet
c/w Lead



No: **EBI4-FIDA**

INTERMITTENT PATTERN

Danfoss



No: **052L0030**

INTERMITTENT 240V

Danfoss
With feet
Inter 99



No: **052L0082**

DOUBLE OUTLET INTERMITTENT

Danfoss
240V Oil



No: **052L0003**

SATRONIC 0.25A

50/60Hz 33%
In 3 Min



No: **ZT930-240V**

E820 DOUBLE OUTLET OIL

No: **T125-1**



INTERMITTENT DOUBLE OUTLET

Oil 2x 4kV 33%



No: **3400820**

INTERMITTENT DOUBLE OUTLET

10kV



No: **3401020**

ZT812-1

No: **ZT812-1**



Oil burner maintenance

Maintainance means reliability

Your oil burner needs the same attention as your car in order to perform at its best. It takes regular cleaning, inspection and servicing to make sure it's in perfect shape and running in a reliable way.

A well-adjusted oil burner is far more efficient and can **save you up to 10% or even more in oil use**. If soot builds up, the oil use will go up with 2-4% per mm soot layer.

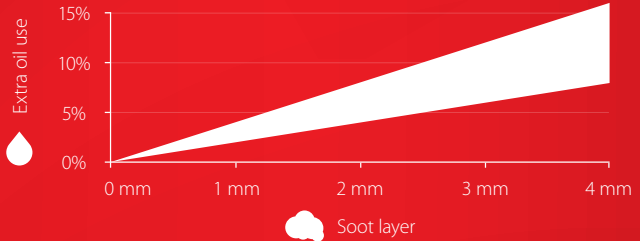

To obtain savings and minimize risk the annual **service should include:**



Replacement of oil nozzle



Replacement of pump filter



Replacement of main cartridge filter



Cleaning and fine tuning

Save up to **10%** in oil use with an annual burner service

An annual service will help ensure:



Energy savings



Money savings



Minimum pollutions



Longer burner lifetime



Avoid break downs



Greener heating

TF830.3 CONTROL BOX

Single Stage
240V

Photocell = MZ
(Sold Separately)

No: **TF830.3**



TF832.3 CONTROL BOX

Two Stage
240V

Photocell = MZ
(Sold Separately)

No: **TF832.3**



TF974 CONTROL BOX

Single Stage
240V

Photocell = MZ
(Sold Separately)

No: **TF974**



TM0720-4 MOD35 CONTROL BOX

Single or Two Stage
240V

Photocell = MZ
(Sold Separately)

No: **TM0720-4**



DKO 970 MOD5

Single Stage
240V

Photocell = MZ
(Sold Separately)

No: **DKO-970 MOD5**



DKO 970 MOD21

Single Stage
240V

Photocell = MZ
(Sold Separately)

No: **DKO-970 MOD21**



DKO 972 MOD5

Two Stage
240V

Photocell = MZ
(Sold Separately)

No: **DKO-972**



DKO 972 MOD5 (110V)

Two Stage
110V

Photocell = MZ
(Sold Separately)

No: **DKO-972 MOD5**



LOA24.171.B2B

Single Stage
240V

Photocell = QRB
(Sold Separately)

No: **LOA24.171.B2B**



OBC82.10

Single or Two Stage
240V

Photocell = LD or LDS
(Sold Separately)

No: **057H8102**



RIELLO MECTRON CONTROL BOX

530SE

Photocell = 3002280
(Sold Separately)

No: **3001156**



RIELLO RDB CONTROL BOX

535RSE/LD

Photocell = 20132526
(Sold Separately)

Standard box No: **3008652**



RIELLO MECTRON BASE

Base for 530SE

No: **3002278**



RIELLO RDB DIGITAL CONTROL BOXES

Grant No: **20117694**

Firebird No: **ZE20035388**

Worcester No: **20037830**



LOA BASE

Base for
Siemens LOA
control boxes.

No: **057H7010**



LOA BASE PLATE

Siemens

No: **2031101**



UNIVERSAL BASE

Satronic
TFI, MMG, MMI

Base No: **S-98**

Entry Plate No: **S-98PLAT**



TMO BASE

Satronic

No: **TMOBASE**



ADAPTER BASE FOR BHO11 - TF830

Satronic

No: **US930**



BHO TO OBC ADAPTER BASE KIT

Danfoss

No: **057H7224**



MZ PHOTOCELL SHORT

Satronic



No: **MZ770S**

MZ PHOTOCELL LONG

Satronic
80mm



No: **MZ770-80**

MZ/FZ PHOTOCELL LEAD

Satronic
750mm



No: **LEAD**

MZ PHOTOCELL FLANGE

Satronic



No: **MZFLANGE**

MZ/FZ STRAIGHT LEAD

Satronic



No: **S01-FZ711S-030**

LD STANDARD PHOTOCELL

Danfoss



Old No: **057H7081**
New No: **057H7107**

LD LONG PHOTOCELL

Danfoss



Old No: **057H7079**
New No: **057H7106**

LDS PHOTOCELL

Danfoss
Extra Sensitive



Old No: **057H7087**
New No: **057H7109**

LDS CLIP

Danfoss



No: **057H7072**

LDS FLANGE

Danfoss



No: **057H7071**

QRB1 PHOTOCELL

Landis & Gyr



No: **QRB1**

QRB1 RED PHOTOCELL

Landis & Gyr
Extra Sensitive



No: **QRB1B**

RIELLO RDB PHOTOCELL

Large



Digital No: **20132550**

Analogue No: **20132526**

RIELLO RDB PHOTOCELL

Small



No: **20132553**

RIELLO MECTRON PHOTOCELL

Riello



Old No: **3002280**

No: **20132573**

SIEMENS IRD1010.1 PHOTOCELL



No: **IRD1010.1**

REMOTE RESET

For Satronic
control boxes.
200mm



No: **FR870**

QRA2 PHOTOCELL

Landis & Gyr



No: **QRA2**

UVZ780 RED

Satronic



No: **UVZ780R**

UVZ780 BLUE

Satronic



No: **UVZ780B**

RIELLO RDB T3 BLAST TUBE

Length 100mm



No: **3002447**

RIELLO RDB T1 BLAST TUBE

Length 100mm



No: **3002507**

RIELLO RDB T5 BLAST TUBE

Length 100mm



No: **3002533**

RIELLO G5 BLAST TUBE

Length 80mm



No: **3005706**

RIELLO R40 CUP SHAPED BLAST TUBE

Length 100mm



No: **3005775**

RIELLO R40 CUP SHAPED BLAST TUBE

Length 110mm



No: **3006001**

RIELLO RDB4 G10 BLAST TUBE

Length 113mm



No: **3006151**

RIELLO RDB CUP SHAPED BLAST TUBE

Length 110mm



No: **3008768**

RIELLO RDB CUP SHAPED BLAST TUBE

Length 110mm



No: **3008769**

RIELLO RDB CUP SHAPED BLAST TUBE

Length 67mm



No: **3008859**

2011 BLAST TUBE

Length 77mm



No: **B03-960-13000**

2011 BLAST TUBE

Length 125mm
Spec: PL6-7-24-10



No: **B03-960-00001**

ELECTROIL BLAST TUBE

Length 77mm



No: **B03-960-00100**

B9 BLAST TUBE

Length 77mm



No: **B03-960-00200**

ST146 KA BLAST TUBE

Length 94mm



No: **B03-00-117-28401**

EOGB X400 BLAST TUBE

Length 82mm



No: **E80-0102**

B20 BLAST TUBE

Length 147mm



No: **BN11728402**

ECOFLAM REDFYRE 60/80 BLAST TUBE

Length 72mm



No: **BFB01021/002**
Alt. No: **65320267**

ECOFLAM ALPHA BLAST TUBE

Upfiring
Length 92mm

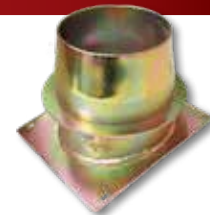

No: **BFB01214/002**
Alt. No: **65320307**

ECOFLAM RAYBURN PJ BLAST TUBE

Length 72mm



No: **BFB01002/002**
Alt. No: **65320255**

ECOFLAM MINOR 1 BLAST TUBE

Upfiring
Length 95mm



No: **BFB01016/002**
Alt. No: **65320265**

ECOFLAM STANLEY 60K BLAST TUBE

Length 72mm



No: **BFB01104/002**
Alt. No: **65320284**

ECOFLAM DONARD 60K 90K BLAST TUBE

Length 174mm



No: **BFB01003/002**
Alt. No: **65320256**

ECOFLAM STANLEY 80 BLAST TUBE

Length 72mm



No: **BFB01014/002**
Alt. No: **65320263**

ECOFLAM BRANDON BLAST TUBE

Upfiring
Length 95mm



No: **BFB01029/002**
Alt. No: **65320270**

ECOFLAM DONARD 80K BLAST TUBE

Length 115mm



No: **BFB01052/202**
Alt. No: **65320275**

ECOFLAM 80K BOILER BLAST TUBE

Length 72mm



No: **BFB01153/002**
Alt. No: **65320286**

ECOFLAM BRANDON TWIN BLAST TUBE

Length 113mm



No: **SYD00240AXX**

ECOFLAM BLAST TUBE

Length 72mm



No: **BFB01071/001**
Alt. No: **65324092**

MINOR 1 NOZZLE HOLDER



No: **GRCR009/10**

MINOR 4 NOZZLE HOLDER

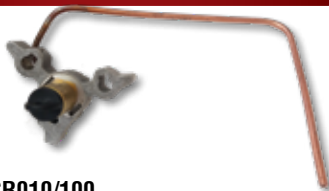

No: **GRCR010/100**

STANLEY MINOR 1 NOZZLE HOLDER



No: **GRCR009/15**

MINOR NOZZLE HOLDER NUT & OLIVE



Nut No: **Y432/1**
Olive No: **Y432/2**

ECOFLAM ST/ST ELBOW

1/8"



Male → Male No: **Y1000/1**
Male → Female No: **Y418**

BENTONE B9 B11 CHECK VALVE



No: **B03-00-119-13201**

B9 NOZZLE HOLDER

Length 165mm



No: **B03-00-117-56901**

B9 NOZZLE HOLDER

Length 212mm



No: **B03-00-117-56902**

RIELLO MECTRON NOZZLE HOLDERS



G2 G3 G5 80mm No: **3005724**
G5 G7 91mm No: **3005709**

RIELLO RDB NOZZLE HOLDERS



RBD1 RDB2 90mm No: **3008642**
RBD4 125mm No: **3008654**

WORCESTER PRESSURE JET GASKET

Foam
Thickness 8mm



No: **87161409020**

X400 'O' RING

Diameter 90mm
Thickness 5mm



No: **E80-0202**

STERLING 35 40 50 90 GASKET

Foam
Width 150mm
Height 150mm
Thickness 4mm



No: **B03-00-118-54201**

INTER 10 11 12 99 & B9 B11 GASKET

Foam
Width 164mm
Height 114mm
Thickness 4mm



No: **B03-04-390-12027**

RAYBURN 400 SERIES GASKET

Foam
Suitable for all
400 series twinhead
burners.



No: **R3798**

RAYBURN BURNERTECH GASKET

Foam
Suitable for
400 series cooker
only burners.
(Burnertech) Gas



No: **R4896**

RIELLO RDB1 RDB2 GASKET

Fibre
Width 172mm
Height 135mm
Thickness 4mm



No: **3005787**

RIELLO R40 G10 GASKET

Fibre
Width 183mm
Height 160mm
Thickness 4mm



No: **3005795**

RIELLO NEOPRENE 'O' RING

Diameter 87mm



No: **3007178**

EOGB 1 BOLT GASKET

Foam
Width 11mm
Inside Diameter 86mm
Thickness 3mm



No: **B03-00-118-83101**

ECOFLAM MINOR 1 GASKET

Fibre
Width 182mm
Height 137mm
Thickness 4mm

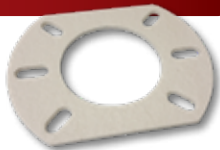

No: **BFG02016**

ECOFLAM MINOR 4 GASKET

Fibre
Width 177mm
Height 144mm
Thickness 4mm



No: **BFG02009/1**

ECOFLAM MINOR 1 GASKET

Neoprene
Width 151mm
Height 123mm
Thickness 5mm



No: **BFG02008/3**

ECOFLAM MINOR 4 GASKET

Neoprene
Width 177mm
Height 144mm
Thickness 5mm



No: **BFG02009/3**

THERMECON MINOR 1 GASKET

Neoprene
Width 151mm
Height 116mm
Thickness 9mm



No: **TH0111382**

THERMECON MINOR 4 GASKET

Neoprene
Width 182mm
Height 150mm
Thickness 10mm



No: **TH0111383**

ALPHA CLEAR GASKET

Clear
Width 140mm
Height 116mm
Thickness 4mm



No: **BFG02028**

ALPHA RED GASKET

Neoprene
Width 11mm
Inside diameter 87mm
Thickness 3mm



No: **BFG02019**

STANLEY MINOR 1 GASKET

Neoprene
Width 165mm
Height 126mm
Thickness 5mm



No: **TH0111382**

CERAMIC GASKET MATERIAL

Thickness - 2mm
1000mm x 600mm



No: **CERPAPER2**

DANFOSS OIL NOZZLES

Developed for optimum combustion of kerosene in domestic oil burners. Oil nozzles type EH and ES are designed for domestic high-pressure oil burners operating with kerosene. The nozzles are equipped with sintered bronze filters. Existing oil nozzles e.g. S and H can directly be replaced by the new ES - EH.



Identification

The nozzle is marked with the following information:



OFTEC-specification

1.80 Specified capacity (kg/h)

OFTEC specification point 800 kPa (8 bar), 1.65 cSt., 790 kg/m³
Capacity tolerance: ± 5%

OK OFTEC Kerosene certification

Serial number for internal use

0.60 Reference capacity (USgal/h)

Reference specification point: 700 kPa (7 bar), 3.4 cSt., 820 kg/m³

60° ES Spray angle & pattern (EH = Hollow) (ES = Solid)

Oil nozzles type EH and ES are designed for domestic high-pressure oil burners operating with kerosene. They are available with 2 different spray angles and sizes from 0.4 to 1.10 USgal/h.

Our existing oil nozzles e.g. 60°S and 80°H can directly be replaced by our new 60°ES - 80°EH.

Application and Features

- Kerosene
- OFTEC certification (OFS E100)
- 100% test of capacity and performance

The nozzles are equipped with sintered bronze filters.

Design

Sizes 0.40-0.60 USgal/h with O-ring sealing

- A Nozzle housing
- C Nozzle cone
- D Orifice disc
- H Filter
- S O-ring holder

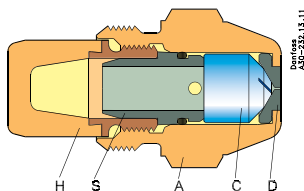

Sizes 0.65-1.10 USgal/h with bottom screw

- B Bottom screw

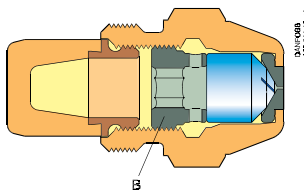

Developed - designed - tested for kerosene application

The kerosene nozzle series meets the requirements of the OFTEC kerosene nozzle standard OFS E100

Spray angles

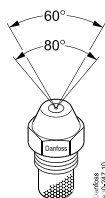

Spray patterns

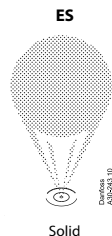
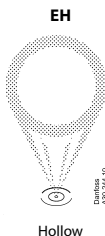

CONVERSION CHART

		1ST CHOICE	2ND CHOICE
DELANAV A	→	H	HFD/HD
DELANAV B	→	S	SFD/SD
FLUIDICS SF	→	SFD	S
FLUIDICS HF	→	HFD	H
FLUIDICS S	→	SD	S
FLUIDICS H	→	HD	H
MONARCH PL	→	H/B	
MONARCH NS	→	HFD	H

		1ST CHOICE	2ND CHOICE
MONARCH PLP	→	B	
MONARCH AR	→	SFD	S
MONARCH R	→	SFD	S
STEINEN PH	→	H/B	
STEINEN H HT	→	HFD	H
STEINEN SS	→	B	
STEINEN S ST	→	SFD	S
STEINEN Q	→	SFD	B/S

RAYBURN

360K Ecoflam	R2989	0.65-80SF
480K MKI Cooker Side	R2510	0.40-80SF
480K MKI Boiler Side	R2511	0.65-80SF
460 Boiler Side	R3770	0.55-80EH
480 Boiler Side	R3771	0.65-80EH
499 Boiler Side	R3772	0.85-80EH
460, 480 & 499 Cooker Side	R3773	0.40-80EH
400K MKI Cooker Only	R2510	0.40-80SF
400K MX Cooker Only	R3773	0.40-80EH
400K Power Flue Cooker Only	R3773	0.40-80EH
460K, 480K, 499K MKII Cooker Side	R2510	0.40-80SF
460K MKII Boiler Side	R3122	0.55-80ES
480K MKII Boiler Side	R2511	0.65-80S
499K MKII Boiler Side	R3599	0.60-60S

WORCESTER BOSCH

Technical Information regarding Worcester GREENSTAR Boilers. The following selection chart shows the oil nozzle fitted to the relevant GREENSTAR Boilers.

Boiler	Output	Nozzle
Camray 25/32	25	0.65 80EH
	27.5	0.75 80EH
	30	0.85 80EH
Camray 18/25	18	0.55-80EH
	21.5	0.60-80ES
	25	0.75-80ES
Camray 12/18	12	0.40-60ES
	15	0.45-60ES
	18	0.55-80ES
Utility 32/50	32	0.85-60ES
	41	1.10-45S
	50	1.25-45S
Danesmoor 18/25	18	0.50-80EH
	21.5	0.55-80EH
	25	0.65-80EH
Utility 50/70	50	1.25-45S
	60	1.50-45S
	70	2.00-45S
Heatslave 25/32	25	0.75-60ES
	28.5	0.75-60ES
	32	0.85-60ES
Heatslave 12/18	12	0.35-80SR
	15	0.40-80ES
	18	0.50-80ES

DANFOSS NOZZLE BOX

Holds 40 nozzles



No: **NOZBOX**

DELAVAN NOZZLES FOR OIL BURNERS RUNNING KEROSENE FUEL

Delavan created its nozzle using bi-metal construction. The brass body and stainless steel metering parts permit machining to close tolerances for precision and consistently high performance.

BRASS transmits heat fast from the nozzle face to reduce the possibility of varnish and oil residue build-up.

STAINLESS STEEL provides that extra Durability for metering parts where wear is a factor.

TYPE W nozzles are neither truly hollow nor solid. These nozzles frequently can be used in place of either solid or hollow cone nozzles between 0.40 and 8.00GPH, regardless of the burner's air pattern.



Precise spray angles and optional spray uniformity through new machining process



Reduced distributor size with shorter tangential slots to avoid plugging

Aerodynamic body configuration

Rolled threads to avoid metal chips and burrs

Sintered filter for maximum protection; sized depending on flow. Mesh strainer supplied on 2.00 GPH and higher flow rates.

100% Tested
 Every nozzle tested. Then we go one step further and clean the test oil from the nozzle to avoid plugging.

NOZZLE REMOVING TOOL



No: **G26-001W**

ABGO NOZZLE BOX

Holds 100 nozzles



No: **AB101NB**

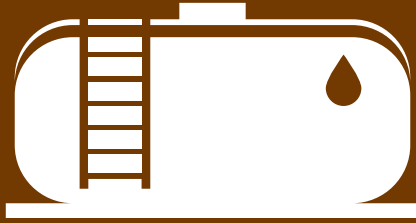

Oil Supply Spares

OIL LINES

BRAIDED

- FOL210** 500mm - 1/4" Female X 1/4" Female
- FOL220** 600mm - 1/4" Female X 1/4" Female
- FOL230** 750mm - 1/4" Female X 1/4" Female
- FOL250** 1000mm - 1/4" Female X 1/4" Female
- FOL310** 500mm - 1/4" Male X 1/4" Female
- FOL320** 600mm - 1/4" Male X 1/4" Female
- FOL330** 750mm - 1/4" Male X 1/4" Female
- FOL350** 1000mm - 1/4" Male X 1/4" Female
- FOL441** 900mm - 1/4" Female Elbow X 1/4" Female
- FOL442** 900mm - 1/4" Male Elbow X 3/8" Female
- FOL443** 900mm - 1/4" Female Elbow X 3/8" Female
- FOL444** 700mm - 1/4" Male Elbow X 1/4" Female
- FOL445** 700mm - 1/4" Female Elbow X 1/4" Male

● ● ● *Best Sellers



LONG LIFE RUBBER (GREEN BIO)

- FOL510** 500mm - 1/4" Female X 1/4" Female
- FOL530** 700mm - 1/4" Female X 1/4" Female
- FOL550** 1000mm - 1/4" Female X 1/4" Female
- FOL640** 200mm - 1/4" Male Elbow X 1/4" Female
- FOL641** 900mm - 1/4" Female Elbow X 1/4" Female
- FOL642** 900mm - 1/4" Male Elbow X 3/8" Female
- FOL643** 900mm - 1/4" Male Elbow X 1/4" Female
- FOL741** 900mm - 1/4" Male Elbow X 1/4" Female Elbow
- FOL742** 900mm - 1/4" Female Elbow X 1/4" Female Elbow



RUBY RED (BRAIDED WITH POLYURETHANE COVER)

- FOL941** 900mm - 1/4" Female Elbow X 1/4" Female
- FOL942** 900mm - 1/4" Male Elbow X 3/8" Female
- FOL943** 900mm - 1/4" Male Elbow X 1/4" Female



CLEAR

- FOL800** 700mm - 1/4" Female Elbow X 1/4" Female

OIL LINE NIPPLE

1/4" Coned x 1/4" BSP



No: **2405005LL**

OIL LINE NIPPLE

1/4" Coned x 1/4" BSP Tapered



No: **2407060**

OIL LINE NIPPLE

3/8" Coned x 1/4" BSP



No: **2407061**

OIL LINE NIPPLE

3/8" Coned x 3/8" BSP



No: **2407062**

OIL LINE NIPPLE

3/8 Coned x 1/4" BSP Tapered



No: **2407069**

COPPER WASHER

For 1/4" Thread



No: **CW04**

NON RETURN OIL VALVES

1/4" No: **2004000**

3/8" No: **2004001**



COMPRESSION BALL VALVE

10mm
Compression
connections

No: **400 10 300**



LEVER BALL VALVE

1/4" No: **VACP9014**

3/8" No: **VACP9038**



M/F BALL VALVE

Female → Male

1/4" No: **VACP40514**

3/8" No: **VACP405010**



SHALLOW BOWL COMPLETE



No: 1/4" - **CR18489**
No: 3/8" - **CR19489**

DEEP BOWL COMPLETE



No: 1/4" - **CR18493**
No: 3/8" - **CR19493**

SHALLOW BOWL ELEMENT

Crosland 489



No: **CR489**

DEEP BOWL ELEMENT

Crosland 493

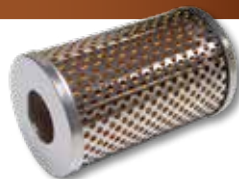

No: **CR493**

BIO SHALLOW BOWL COMPLETE



No: 1/4" - **CR18489B**
No: 3/8" - **CR19489B**

BIO DEEP BOWL COMPLETE



No: 1/4" - **CR18493B**
No: 3/8" - **CR19493B**

BIO SHALLOW BOWL ELEMENT

Bio 489



No: **CR489-B**

BIO DEEP BOWL ELEMENT

Bio 493



No: **CR493-B**

FILTER ELEMENT 414



No: **CR414**

FILTER ELEMENT 555



No: **CR555**

FILTER ELEMENT 4009



No: **CR4009**

WASHABLE FILTER ELEMENT



No: **E03-034Q**

GOK FILTER HOUSING

3/8" connections



No: **1300000**

MANN W712 FILTER

For use with
Gok 1300000



No: **MANW712**

FILTER BOWL COMPLETE 3/8"



No: **38FILTER**

MESH FILTER ELEMENT 3/8"

For use with 38FILTER



No: **38ELEMENT**

OIL FILTER ISOLATION VALVE



No: **OFV1**

OFV1 FILTER ELEMENT



No: **AVF1000K**

ALUMINIUM FILTER BOWL 1/2"

Includes
washable filter.



No: **A02-70302/AL**

GEM 4000 FILTER ELEMENT



No: **CTGEM4000**

TANKMASTER FILTER ELEMENT



No: **TM4660F**

UNIVERSAL TANK FILTER

'One kit fits all'



No: **ABTANKFILTER**

NYLON FILTER ELEMENTS 42mm

Pack of 10



No: **TM4660F-10**

NYLON FILTER 'O' RINGS

Pack of 10



No: **TM4660F-0**

CENTRO 1/4" ALUMINIUM FILTER



No: **GA-V7045201ALS**

CENTRO 3/8" ALUMINIUM FILTER



No: **GA-V7045101ALS**

CENTRO FILTER ELEMENT



No: **GA-U604500015**

CENTRO 'O' RING SEAL KIT



No: **GA-U03198**

CENTRO FILTER BRACKET



No: **GA-V70410**

FILTER ELEMENT FOR GOK GS2000



No: **3006025**



Leaders In Heating & Ventilation Components

Engineer Accessories

Talk to us today about the full range of Anglo Nordic Engineered Products!



Ash Vacuum Cleaner & Accessories

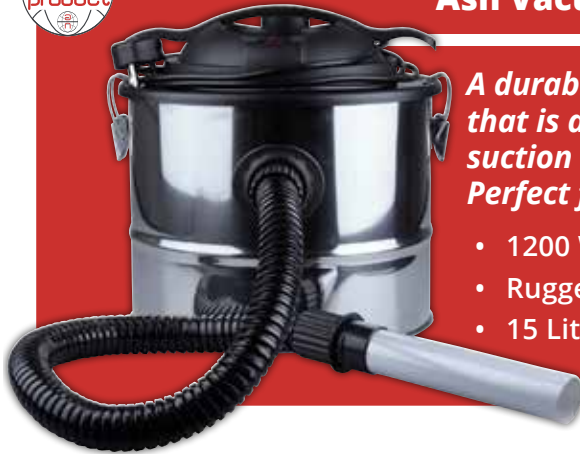

A durable 1200 watt vacuum cleaner that is designed for large-particle suction that can clog domestic units. Perfect for boilers, fireplaces, and BBQs.

- 1200 Watt Motor
- Rugged Construction
- 15 Litre Capacity For Large Jobs
- Replaceable Filters

Anglo Nordic Fire Valve Tester

Designed and engineered by Anglo Nordic to be safe, cost effective, and faster than other testers.

- 0°C - 120°C Thermostat
- 3-Minute Testing Time
- 230V Operation
- Ultra-Rugged Design
- Fits All Types of Capillary Fire Valves



OIL TANK OUTLET KITS



TANK KIT A

UCV with single outlet.



No: **TANKKITA**

TANK KIT B

UCV with single 90° outlet.



No: **TANKKITB**

TANK KIT C

UCV with double 90° outlet.



No: **TANKKITC**

TANK KIT D

UCV with double outlet.



No: **TANKKITD**

NEW STYLE ULTRA COMPACT VALVE



Short Handle No: **UCV-S**
Long Handle No: **UCV-L**

ISOLATION FILTER



No: **UCV-FILTER**

ULTRA COMPACT VALVE

Requires key to operate.



No: **UCV**

COMPACT VALVE KEYS



Flat No: **UCV-KEY-F**

Hooked No: **UCV-KEY-H**

ELBOW 90°



No: **UCV-ELB**

TEE



No: **UCV-TEE**

OFFSET TEE

For adding a third or fourth filter and line. (Or more)



No: **UCV-OTEE**

RETRO FIT HANDLE

Kit to install new style handle to older UCVs. (Includes new filter assembly)



No: **UCV-RET**

EXTENSIONS

Used to offset filters away on ridged tanks.

No: **UCV-EXT-75MM**

No: **UCV-EXT-100MM**

No: **UCV-EXT-150MM**

No: **UCV-EXT-125MM**

No: **UCV-EXT-200MM**



REPLACEMENT HANDLES

Includes a thin walled socket to remove and replace handle.

10x Short Handles No: **UCV-SH-10**

10x Long Handles No: **UCV-LH-10**

5x Long, 5x Short Handles No: **UCV-MH-10**



TOBY KNOB TYPE OCV'S

4-8cc No: **3904200**
4-13cc No: **3904205**



TOBY TRADITIONAL OCV'S

3-9.5cc No: **3904135**
4-13cc No: **3904101**
4-20cc No: **3904110**
6-19cc No: **3904124**



TOBY ELECTRIC TOP

Includes adaptor plate.

12V No: **3904025**
230V No: **3904026**



TOBY ADAPTOR PLATE

To enable use with BM style float valves.

No: **3904029**



TOBY HOT ROD

No: **3904057**



TOBY GASKET

Suitable for all DVR 5 float controls

No: **3904059**



OIL SOLENOID VALVES

Viton seals for use with kerosene.
Working pressure 0-16bar.
Available in 12V, 24V, 110V or 230V.
Normally Closed - Energise to open.
Opening/Closing time 30ms.
Solenoid valve can be mounted in any position without affecting performance.
(Coil must be used in vertical position).



1/8" N/C Solenoid - Viton Seal	S1010.00.040-1/8VS
1/4" N/C Solenoid - Viton Seal	S1010.01.050-1/4VS
3/8" N/C Solenoid - Viton Seal	S1010.02-3/8VS
1/2" N/C Solenoid - Viton Seal	S1010.03-1/2VS
3/4" N/C Solenoid - Viton Seal	S1010.05-3/4VS
1" N/C Solenoid - Viton Seal	S1010.05-1VS
1 1/4" N/C Solenoid - Viton Seal	S1010.06-11/4VS

TIGERLOOP DE-AERATOR

Original, outdoor fitment. A Tigerloop makes a one-pipe system possible for all types of oil heating installations helping to ensure environmental safety, cost effectiveness and reliability. In an oil heating system using a Tigerloop, all oil passes through the automatic oil de-aerator, which effectively removes all gas/air bubbles from the system. This eliminates oil pump and nozzle problems associated with gas/air in the oil.

No: **B03-00-117-48901**



INDOOR METAL TIGERLOOP BIO DE-AERATOR

The Tigerloop Bio model is constructed externally of metal materials making it suitable for both indoor and outdoor installation in the UK & IE.

With the addition of a simple to fit 10mm vent pipe the removed air can be vented safely to the outside, ensuring only pure oil is passed through to the burner.

No: **3008024**



FLOCO DE-AERATOR

Flow-Control 3/K-1 is for fuel oil (DIN 51603-1), diesel (DIN EN 590) also biodiesel and vegetable oils (rape oil).

The device must not be subjected to undiluted additives, alcohol and acids. TÜV-tested (S 159/02)

No: **69930**



GOK DE-AERATOR

c/w Filter. GS 2000 is a combination of an oil filter, de-aerator and shut-off valve. It is designed to be installed on oil combustion plants running on a single pipe system. With this system, a return pipe to the tank becomes superfluous which lowers costs and reduces the risk of damage to the environment in the event of a leak.

No: **3006021**



GOK ANTI-SIPHON VALVE 3/8"

Prevents oil siphoning on installations requiring suction lift. Also works as a safety device should an oil leak occur.

Adjustable version can be set depending on tank height.

No: **GS2060**



TEDDINGTON KBB FIRE VALVES

KBB Fire Safety Valve

Why take the risk with anything else?



The KBB fire valve is designed as a fire safety shut-off valve for use on oil burning equipment.

The valve is installed in the oil supply pipeline outside the building with the sensor mounted firmly inside the appliance above the burner.

65°C FIRE VALVE

KBB/65/1.5	1.5m
KBB/65/3	3.0m
KBB/65/6	6.0m
KBB/65/9	9.0m
KBB/65/12	12.0m
KBB/65/16	16.0m
KBB/65/20	20.0m

90°C FIRE VALVE

KBB/90/2	2.0m
KBB/90/3	3.0m
KBB/90/6	6.0m
KBB/90/9	9.0m
KBB/90/12	12.0m
KBB/90/16	16.0m
KBB/90/20	20.0m

Teddington Fire valves have 1/4" female connection ports.

FIRE VALVE TEST UNIT



No: **KBT1000**

- Integrated single compact unit
- Adjustable temperature setting
- Simple controls
- 230V operation
- Light weight robust construction
- Eliminates hot kettles of water
- Testing time approx 3 minutes
- 'Ready' indicator light
- Will test all types of fire valves
- Conforms to EN 60730-1:1995

The single unit test box is designed to eliminate the need for jugs of hot water to test the operation of the fire valve at initial installation or during regular servicing.

It provides a safe and simple solution to valve testing.

REMOTE ACTING FIRE VALVE – 7mm Phial

The use of remote sensing fire valves is covered by BS 5410: Part 1: 1997 which is referenced as a requirement in the Building Regulations and Standards.



66°C FIRE VALVE

BBRAF6615C	1.5m
BBRAF6630C	3.0m
BBRAF6660C	6.0m
BBRAF6690C	9.0m
BBRAF66150C	15.0m

90°C FIRE VALVE

BBRAF9015C	1.5m
BBRAF9030C	3.0m
BBRAF9060C	6.0m
BBRAF9090C	9.0m

These Fire valves have 3/8" female connection ports.

HAND WHEEL FIRE VALVE

3/8" or 10mm compression



No: **1401002**

SPARE WHEEL

Spare Hand Wheel for Fire Valve



No: **1402000**

LEVER FIRE VALVE KIT

3/8" or 10mm compression



3/8" No: **1403000**
 1/2" No: **1403007**
 3/4" No: **1403014**

DEADWEIGHT FIREVALVE KIT ONLY

9 metre
72°



No: **1404015**

TANKMASTER BODY COMPLETE

Designed to fit steel or plastic oil heating storage tanks. Eliminates the need for a separate gate valve, level gauge, filter and several pipe fittings.

- Dimensions - 155mm x 80mm
- Sight Tube - 4ft 6" or 6ft (sold separate)
- Tank Connection - 1/2" BSP
- Oil Level Valve - Pull to read (self closing)
- Flow Rate - Up to 36 litres/hour
- Oil Line Outlet - 10mm compression
- Complies with BS799 Part 2



The filter should be replaced whenever the boiler is serviced and is not washable.

No: **TM4790**

SIGHT TUBE



4ft 6" No: **TM4480**
6ft No: **TM4500**

UPVC SHIELD



4ft 6"

No: **COM2024**

TANK GAUGE ADAPTER 90mm



No: **TM4545**

TANK GAUGE ADAPTER 180mm



No: **TM4547**

FILTER ELEMENT



No: **TM4660F**

SIGHT GAUGE TOP CAP



No: **COM2180**

PULL TO READ VALVE LEVERNo: **TM4155****BOWL BOLT & SEAL**No: **TM4675/4390****ON/OFF HANDWHEEL**No: **TM4310****FILTER BOWL BODY**No: **TM4326****'O' RING SET**

9 Piece

No: **TM4400****GREEN FLOAT**No: **SG2000-P****TANK GAUGE**4ft 6" No: **SG1550**6ft No: **SG1552****CONTENTS GAUGE**4ft No: **D1600**6ft No: **D1610****TANK GAUGE ISOLATION VALVE**No: **PB5290****PVC CLEAR TUBE**30m Coils
Also sold per metreNo: **COM2080**

LOCKABLE VENT CAP

2" (Fits most tanks)
Locks with padlock.



No: **3006055**

PLASTIC VENT CAP

2" (Fits most tanks)



No: **1703104**

TANK WATER ABSORBER



489ml No: **3011022**

1.59L No: **3011023**

COPPER TUBE

10mm



10 metres No: **TUBE1010P**

25 metres No: **TUBE1025P**

COPPER TUBE INSERT

10mm



No: **TM4172**

LOCKABLE VENT CAP

2" (Fits most tanks)
Locks with key.



No: **3006056**

METAL VENT CAP

2" (Fits most tanks)



No: **3006052**

TOP OFF TANK VALVE

Draw oil from the top of the tank.



No: **TTV-01**

COATED COPPER TUBE

10mm



10 metres No: **TUBE1010C**

25 metres No: **TUBE1025C**

CASH ACME A31S PRV

Oil, Gas or Water
4PSi outlet (adjustable)
3/8" connections
1/4" for gauge



No: **3001002**

GOK SMARTBOX® TANK GAUGE

Wired tank gauge which displays tank level in %, litres or height (cm).



No: **1703200**

ANALOGUE OIL TANK CONTENTS GAUGE

Sends the oil level direct to your Smart phone. Daily/weekly/monthly



No: **1705005**

COMPACT TANK ALARM

ATEX certified
Float switch supplied.
Battery operated



Steel Tank No: **3808053**

Plastic Tank No: **3008052**

SMS TANK ALERT

Sends the oil level direct to your Smart phone. Daily/weekly/monthly



No: **6800200**

SINGLE FILL POINT CABINET

Fill Point Cabinet
2" Single Fill
(Top Entry)



No: **1707000**

FUEL TANK TRANSFER PUMP

100 litres/min



No: **3805050**

OUF OIL LIFTERS

The OUF88 range of oil lifters should satisfy most domestic market requirements. Can be used to replace the no longer available BM346 lifter. Suction lift 8 litres @ 8 metres vertical and up to 25m horizontal pipe run on 8mm inside diameter pipe.

This lifter has a third port to be used for an overflow pipe which has to be returned to the tank.

If it is not possible to do so an IR leak detector driptray has to be used. (Sold Separately)



Oil Lifters

OUF 3.5 ltr	6808000
OUF 12 ltr	6808010
IR Drip Tray (3.5 ltr)	6800232
IR Drip Tray (12 ltr)	6800233

PUMP TYPE	Suction Solenoid Pump
LIFTING HEIGHT (MAX.)	8 m. vertical (8 mm I.D. tube)
MAX. HORIZONTAL DISTANCE	100 m. horizontal (8 mm I.D. tube)
OUTLET FLOW RATING (8 mm I.D. tube)	8 l/hr at: 8 m vertical & 25 m horizontal 15 l/hr at: 5 m vertical & 25 m horizontal
INLET CONNECTION	3/8" F BSP
OUTLET CONNECTION	3/8" F BSP
OVERFLOW OUTLET CONNECTION	1/2" F BSP
POWER SUPPLY	AC 230V, 50Hz
POWER CONSUMPTION	50 W
RESERVOIR TOTAL CAPACITY	3,5 Litre (Max: 12 litres)
DIMENSIONS (W x D x H)	240 x 130 x 335 mm (Max: 350 x 225 x 345)
WEIGHT	3 kg (Max: 4 kg)
FUEL TYPE	Kerosene and Diesel Oil

If the oil lifter is being fitted externally, it must be installed inside a weather proof box.

Weather Proof Boxes

400x300x200mm	3005002
500x400x200mm	3005005
600x400x230mm	3005006
800x600x300mm	3005008



WATCHMAN TANK GAUGES



SENSiT GAUGE

If your tank is 'SENSiT Ready', all you need is to buy the SENSiT USB receiver.
Check if you have the orange sticker on your tank (as shown below). This means you should have the grey transmitter Watchman Sonic Advanced pre-installed on your tank.

If you do not have the orange sticker and the grey Watchman Sonic Advanced transmitter as mentioned above, the SENSiT USB receiver will not work on its own.

You will need to get the full SENSiT Smart WiFi tank level monitoring kit which contains of the SENSiT USB receiver and the grey transmitter Watchman Sonic Advanced.

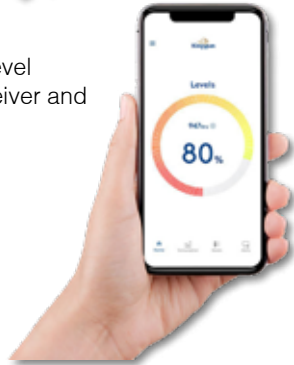

Full kit No: **WASONICADVANCED**

WATCHMAN ANYWHERE

Monitor oil levels via smartphone.



No: **WAANYWHERE**

LITHIUM BATTERY (CURRENT MODELS)

Suitable for all current ultrasonic models.
3V



No: **CR2430**

COMPRESSION COUPLING



8mm No: **YKK6108**
10mm No: **YKK61010**

COMPRESSION ELBOW



8mm No: **YKKCEL08**
10mm No: **YKKCEL10**

COMPRESSION TEE



8mm No: **YKKCTE08**
10mm No: **YKKCTE10**

COMPRESSION STOP END



8mm No: **YKK8MMCOMPBLANK**
10mm No: **YKK10MMCOMPBLANK**

COMPRESSION → FEMALE COUPLING



8mm → 1/4" No: **YKK612814**
8mm → 3/8" No: **YKK612838**
10mm → 1/4" No: **YKK6121014**
10mm → 3/8" No: **YKK6121038**

COMPRESSION → MALE COUPLING



8mm → 1/4" No: **YKK611814**
8mm → 3/8" No: **YKK611838**
10mm → 1/4" No: **YKK6111014**
10mm → 3/8" No: **YKK6111038**

COMPRESSION → FEMALE ELBOW



8mm → 1/4" No: **YKKELBFE814**
10mm → 1/4" No: **YKKELBFE1014**
10mm → 3/8" No: **YKKELBFE1038**

COMPRESSION → MALE ELBOW



8mm → 1/4" No: **YKKELBOW814**
10mm → 1/4" No: **YKKELBOW1014**
10mm → 3/8" No: **YKKELBOW1038**

REDUCING BUSH



3/4" → 1/2" No: **BFBSH3412**
1/2" → 3/8" No: **BFBSH1238**
3/8" → 1/4" No: **BFBSH3814**
1/4" → 1/8" No: **BFBSH1418**

OLIVE



6mm No: **OLIVE6**
8mm No: **OLIVE8**
10mm No: **OLIVE10**
15mm No: **OLIVE15**

FLARED STRAIGHT

- 10mm → 10mm No: **910388**
- 10mm → 1/4" male No: **910604**
- 10mm → 3/8" male No: **910612**
- 10mm Nut to Suit No: **910094**



FLARED ELBOW

- 10mm → 10mm No: **912129**
- 10mm → 1/4" male No: **912062**
- 10mm → 3/8" male No: **912089**
- 10mm Nut to Suit No: **910094**



BLACK IRON NIPPLE

- 1/4" No: **IFBLNIP14**
- 3/8" No: **IFBLNIP38**
- 1/2" No: **IFBLNIP12**
- 3/4" No: **IFBLNIP34**



BLACK IRON PLUG

- 1/4" No: **YH14PLUG**
- 3/8" No: **YH38PLUG**
- 1/2" No: **YH12PLUG**
- 3/4" No: **YH34PLUG**



BLACK IRON CAP

- 1/4" No: **YH14CAP**
- 3/8" No: **YH38CAP**
- 1/2" No: **YH12CAP**
- 3/4" No: **YH34CAP**



BLACK IRON SOCKET

- 1/4" No: **YH14SOCKET**
- 3/8" No: **YH38SOCKET**
- 1/2" No: **YH12SOCKET**
- 3/4" No: **YH34SOCKET**



BLACK IRON ELBOW

- 1/4" No: **252MTB**
- 3/8" No: **252MTC**
- 1/2" No: **252MTD**
- 3/4" No: **252MTE**



BLACK IRON REDUCING NIPPLE

- 3/8" → 1/4" No: **420 86 906**
- 1/2" → 1/4" No: **420 86 909**
- 1/2" → 3/8" No: **420 86 912**
- 3/4" → 1/2" No: **420 86 921**



BLACK IRON TEE

- 1/4" No: **154MMB**
- 3/8" No: **154MMC**
- 1/2" No: **154MMD**
- 3/4" No: **154MME**



TUBE CUTTERS

- No: **TL020** Cuts 6-22mm
- No: **TL031** Spare cutting wheel



BUNDED TANKS

Even where current regulations might permit the use of single skin tanks, the additional environmental protection offered through the use of Atlas Bunded Tanks is strongly recommended for any oil storage.

Guaranteed for 10 years this well respected range of tanks offers an excellent combination of shapes, capacities and features. With designs to suit all locations, from narrow width for domestic situations with limited space through to large capacity for commercial, industrial and agricultural use, the Atlas range of bunded tanks has a proven track record for over 10 years. When you invest in Atlas you are buying strength, affordability and reliability - fully specified and approved. Tanks you can trust



ATLAS 1200 LPBA

Capacity 1200ltr
Length 2000mm
Width 1400mm
Height 1000mm



No: **1200LPBA**

ATLAS 1000 BSA SL

Capacity 1000ltr
Length 1890mm
Width 640mm
Height 1440mm



No: **1000BSASL**

ATLAS 1300 BHA

Capacity 1300ltr
Length 1800mm
Width 1300mm
Height 1300mm



No: **1300BHA**

ATLAS 1000 BSA

Capacity 1000ltr
Length 2050mm
Width 710mm
Height 1515mm



No: **1000BSA**

ATLAS 1900 BHA

Capacity 1900ltr
Length 2190mm
Width 1540mm
Height 1460mm



No: **1900BHA**

ATLAS 1225 BSA

Capacity 1225ltr
Length 2100mm
Width 860mm
Height 1550mm



No: **1225BSA**

EXOCET FUEL ADDITIVES

A specialist fuel additive designed to improve the burn quality of domestic kerosene when used in range-style cookers and/or where vaporising burners are being utilised.

Ideal for burners which continually 'coke' up or have fuel pipe blocks.

- Lowers char value
- Reduces build up of carbon deposits and soot
- Inhibits growth of deposits in fuel storage tanks
- Minimises the potential for fuel tank corrosion
- Increases the fuel shelf life
- Reduces service problems
- 1 Litre of additive treats 5000 litres of fuel (1:1000)



Exocet Cooker

200ml No: **X01482TA200**

1 Litre No: **X01482TA1**

Exocet Boiler

200ml No: **X01410H0200**

1 Litre No: **X01410H01**

OIL METERS - MECHANICAL

- Suitable for heating oil, naphtha, diesel and petrol applications
- Volume display on roller counter, in litres
- For horizontal, vertical or inclined mounting
- Threaded or flanged connections
- Suitable for temperatures for up to 130°C



VZ04	4mm (1/8")	Flow Range 1 – 50 litres/hr
VZ08	8mm (1/4")	Flow Range 4 – 135 litres/hr
VZ015	15mm (1/2")	Flow Range 10 – 400 litres/hr
VZ020	20mm (3/4")	Flow Range 30 – 1000 litres/hr
VZ025	25mm (1")	Flow Range 75 – 2000 litres/hr
VZ040	40mm (1" 1/2)	Flow Range 225 – 6000 litres/hr
VZ050	50mm (2")	Flow Range 750 – 20,000 litres/hr
VZ04-RV	4mm (1/8") c/w pulse output	Flow Range 1 – 50 litres/hr
VZ08-RV	8mm (1/4") c/w pulse output	Flow Range 4 – 135 litres/hr
VZ015-RV	15mm (1/2") c/w pulse output	Flow Range 10 – 400 litres/hr

The Envirogreen Low NO_x Range from Firebird

Boiler Technology at its best

60mg/kWh
The Lowest Low NO_x
Boiler Range



SUPERIOR HEATING SOLUTIONS
SINCE 1980

www.firebird.uk.com

 **Firebird**®
Central to Heating

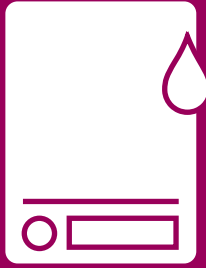

Oil Boiler Spares

BOILER CONTROL STAT

50-80°C



No: **ACC000STA**

POPULAR LIMIT STAT

110°C



No: **ACC000LMT**

OVER HEAT STAT

87°C

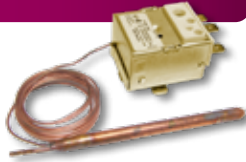

No: **ACC0000HS**

OVER RUN STAT



No: **ACC000ORS**

RELAY TANK STAT

78°C
For Combi



No: **ACC000RTS**

EARLY ALERT STAT

87°C



No: **ACC000EAS**

DUAL STAT

P5 Popular
With pocket



No: **ACC000DST**

DUALSTAT D5

Heatpac



No: **ACC000THR**

FROST STAT

No: **ACC000FST**



STAT POCKETS

No: **ACC000PKT**
No: **ACC003PKT**



MECHANICAL TIME CLOCK

Single Channel



No: **ACC000CLK**

MECHANICAL TIMER KIT

Standard efficiency
boilers



No: **ACC000TIM**

ELECTRONIC TIMER KIT

Condensing
boilers



No: **ACC000ETM**

COMBI PCB BOARD



No: **ACC000PCB**

RELAY 230V AC



No: **ACC000RLY**

RELAY BASE

11 Pin



No: **ACC000BAS**

PRESSURE SWITCH



No: **ACC000PSW**

RDB DIGITAL CONTROL BOX

Fitted with
Post Purge



No: **ZE20035388**

BOILER PROBE

White Thermistor



No: **ACC000WTP**

FLOW SWITCH PROBE

Red Thermistor



No: **ACC000RTP**

PLATE HEAT EXCHANGER



No: **ACC025PHE**

PLATE HEAT EXCHANGER



No: **ACC031PHE**

PLATE HEAT EXCHANGER WASHERS

Set of four



No: **ACC000PHW**

PRESSURE RELIEF VALVE



No: **ACC00MSRV**

FLOW SWITCH

Combi MK II



No: **ACC00MFSW**

FLOW SWITCH COMPLETE

MK I Upgrade



No: **ACC00RSFSW**

CIRCULATING PUMP



No: **ACC130PMP**

PUMP ISOLATION VALVE

22mm



No: **ACC022PIV**

THERMOSTATIC MIXING VALVE



Pre 19

Post 19

Pre 19 No: **ACC00MTMV**

Post 19 No: **ACC00HBWMV**

BALL VALVE

22mm



No: **ACC022VAL**

EXPANSION VESSEL

12 Litre



No: **ACC012PVL**

EXPANSION VESSEL

14 Litre



No: **ACC014PVL**

EXPANSION VESSEL

18 Litre



No: **ACC018PVL**

EXPANSION VESSEL HOSE

1/2" F Elb x 3/4" F Str



No: **ACCCOMHOS**

FILLING LOOP

400mm



No: **ACC000FLH**

NON-RETURN CHECK VALVE

15mm



No: **ACCCOMDCV**

FILLING LOOP VALVE



No: **ACC015FCV**

AUTO AIR VENT



No: **ACCCOMAAV**

NYLON CHECK VALVE



No: **ACC000PCV**

PRESSURE GAUGE

Combi/System



No: **ACCCOMPRG**

CHECK VALVES



Male → Male No: **ACC034MMC**
 Male → Female No: **ACC034MFC**
 Female → Male No: **ACC034FMC**

CONDENSATE PUMP KIT



No: **ACCENVPNP**

SMALL SNORKEL HOSE



No: **ACC000SSH**

CONDENSATE TRAP



No: **ACC000TRP**

MISCELLANEOUS PARTS



Description

No

Combustion Door Insulation 50/70/90

ACC090GSK

Combustion Door Insulation 120

ACC120GSK

Combustion Door Insulation 150

ACC150GSK

Combustion Door Insulation 200

ACC200GSK

Combustion Door Insulation 250

ACC250GSK

Combustion Door Insulation 310

ACC310GSK

Combustion Door Insulation C20/C26/C35 (No Graphite Required)

ACC000DDS

Combustion Door Insulation C44/C58

ACC044GSK

Combustion Door Insulation C73

ACC073GSK

Combustion Door Insulation C100

ACC100GSK

Graphite Board C44/C58

ACC044GRA

Graphite Board C73

ACC073GRA

Graphite Board C100

ACC100GRA

Heatpac Key

ACC000KEY

Heatpac Lock

ACC000LCK

CONTROL STAT



No: **TH11010989**

LIMIT STAT



No: **TH11010988**

MANUAL LIMIT STAT



No: **THMAN10077**

DUALSTAT



No: **TH11017262**

SECONDARY HEAT EXCHANGER SEAL

Suitable for
condensing models
12/24, 24/30



No: **TH40724445**

COMBUSTION DOOR SEAL

Suitable for
condensing models
12/20, 12/16, 16/25

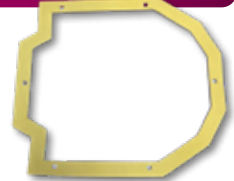

No: **TH40724446**

EXPANSION VESSEL

10 Litre



Vessel No: **TH23016525**

Hose No: **TH22222217**

AIR SNORKEL HOSE

Clips sold seperately



Wall Hung No: **TH72818371**

Floor Standing No: **TH72811296**

FLUE GASKET



No: **THGAF075**

PRESSURE GAUGE

1/4" Rear connection



No: **TH20716591**

BOILER CONTROL THERMOSTAT

Combi MKII,
Multipass, Euroflame
Vortex Models
(pre Sept 15)



No: **TPBS34**

OVER HEAT THERMOSTAT

Combi MKII, V3
Euroflame, Multipass
Vortex Models
(pre Sept 15)



No: **TPBS33**

TEMPERATURE CONTROL KNOB

All models
(pre Sept 15)



No: **TPBS30**

TEMPERATURE CONTROL KNOBS

(post Sept 15)



VBS136

VBS135

Combi models No: **VBS136**

Non-combi models No: **VBS135**

BOILER CONTROL THERMOSTAT

Vortex Models
(post Sept 15)



No: **VBS146**

OVERHEAT THERMOSTAT

Vortex Models
(post Sept 15)



No: **VBS147**

PRIMARY STORE STAT

Combi MKII



No: **MPCBS25**

FROST STAT

All external models



No: **EFBS23**

DUAL THERMOSTAT

Euroflame Boilerhouse
Multipass Boilerhouse



No: **DSBH**

DUAL THERMOSTAT

Vortex Boilerhouse



No: **DSBH03LC**

CONTROL PANELS - SERIAL NUMBER & ADDRESS REQUIRED WHEN ORDERING

Description	No
Vortex Pro Combi Internal 21-26kW (Pre 24/10/14)	MPCBS104
Vortex Pro Combi Internal 36kW (Pre 24/10/14)	MPCBS104X
Vortex Pro Combi External (Post 24/10/14)	MPCBS105N
Vortex Pro Combi Internal (Post 24/10/14)	MPCBS114N
Vortex Eco External W/H non-system	MPCBS106
Vortex Eco External W/H system	MPCBS106X
Vortex Eco Internal W/H non-system	MPCBS108
Vortex Eco Internal W/H system	MPCBS108X



MECHANICAL PROGRAMMER



No: **MTKIT**

DIGITAL PROGRAMMERS



Single Channel

No: **ETKIT**

Twin Channel

No: **EPKIT**

BOILER ROCKER SWITCH

On/Off
External models



No: **EFBS21**

HEATING ROCKER SWITCH

On/Off Double Pole
Neon



No: **EFBS19**

TEMPERATURE CONTROL PCB

Vortex Pro
combi
(post 08)



PCB only No: **MPCBS96**

PCB & sensor No: **MPCBS54E**

TEMPERATURE CONTROL PCB

Combi V3
Vortex Pro
combi (pre 08)



PCB only No: **MPCBS97X**

PCB & sensor No: **MPCBS54X**

PRESSURE RELIEF VALVE 2.5BAR

Combi MKII Internal
Euroflame Internal
Multipass System



No: **MPCBS28**

PRESSURE RELIEF VALVE 2.5BAR

Combi MKII External
Euroflame External



No: **MPCBS47**

PRESSURE RELIEF VALVE 2.5BAR

Combi V3 Internal
Vortex Pro Combi
Vortex Pro Internal
Vortex Eco Wallhung



No: **MPCBS50**

PRESSURE RELIEF VALVE 2.5BAR

Combi V3 External
Vortex Pro External
Vortex Eco



No: **MPCBS50X**

WATER PRESSURE GAUGE

Combi MKII Internal
Combi V3
Euroflame System
Multipass Internal



No: **MPCBS24**

WATER PRESSURE GAUGE

Combi MKII External
Multipass External
Vortex Pro External
Vortex Eco S/System



No: **MPSS02**

WATER PRESSURE GAUGE

All Vortex models



No: **VBS09**

CONDENSATE TRAP

Vortex Models



No: **VBS02**

MAG ONE SYSTEM CLEANER

Magnetic system filter



No: **VM01**

FILLING LOOP KIT

c/w Valves



No: **MPCBS30**

CIRCULATING PUMP



Pump No: **VBS159**
 Hot water lead No: **VBS126A**
 Heating lead No: **VBS126B**

LOW PRESSURE SWITCH

Combi V3
 Vortex Pro Combi



No: **MPCBS49X/A**

CIRCULAR FLOW SWITCH

Vortex Pro Combi
 21-26kW
 36kW (post 08)



No: **MPCBS71X**

SQUARE FLOW SWITCH

Vortex Pro Combi
 36kW (pre 08)



No: **MPCBS71NT**

AUTO AIR VENT

All models



No: **MPCBS29**

MANUAL AIR VENT 3/8"

Vortex Pro Combi



No: **MPCBS68**

FIBRE WASHERS



15mm No: **MPCBS34S**
 22mm No: **MPCBS34M**
 Diverter Valve No: **MPCBS34L**

FLOW RESTRICTOR

All combi models



No: **MPCBS39**

TURBULATORS



360mm No: **VBS05**
 476mm No: **VBS03**
 Wallhung No: **WBS01**

NEONS

Red No: **MPCBS46**
 Amber No: **EFBS25**
 Green No: **MPCBS45**



EXPANSION VESSEL 8 LITRE

Vortex Eco Wallhung



No: **WBS07**

EXPANSION VESSEL 10 LITRE FLAT

Vortex Pro
Combi 21kW
(pre 14)



No: **MPSS08**

EXPANSION VESSEL 12 LITRE FLAT

Vortex Pro
26-36kW



No: **VBS06**

EXPANSION VESSEL 16 LITRE

Vortex Pro
36-46kW



No: **VBS38**

EXPANSION VESSEL 24 LITRE

Multipass
140/160, 160/200
Vortex Pro Combi
(post 14)



No: **VBS124**

EXPANSION VESSEL 10 LITRE

Euroflame 50/70,
70/90 & external.
Vortex Pro 15-21kW
& 15-26kW (pre 08)



No: **MPCBS27**

EXPANSION VESSEL 12 LITRE

Euroflame Int. 50/90, 90/120
Multipass 50/70, 70/90, 90/140
Vortex Pro Combi 26kW (pre 14)
Combi MKII, V3
Vortex Eco, Pro 15-26kW (post 08)



No: **MPSS01**

EXPANSION VESSEL 14 LITRE

Vortex Pro
Combi 36kW
(pre 14)



No: **MPCBS70**

VESSEL FLEXI HOSES



Combi MKII, Multipass Sealed System

No: **MPCBS31**

Euroflame Sealed System, Multipass

No: **MPSS04**

Vortex Eco, Pro Combi 26-36kW (pre 14)

No: **MPCBS79**

Vortex Pro Combi (post 14)

No: **VBS125**

Vortex Pro Ext. 15-21kW, Pro Combi (pre 14)

No: **VBS95**

Vortex Pro Wallhung

No: **WBS08**

BAFFLES

Description	No
-------------	----

MARK II

Combi 70 Full Set	EFBS30
Combi 90 Full Set	MPBS13
Combi 90 Bottom Baffles	MPBS13X

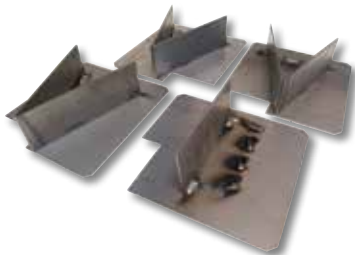

EFBS30

V3

Combi 70 Full Set	EFBS30
Combi 90 Full Set	MPCBS51
Combi 90 Bottom Baffles	MPCBS51X
Combi Max Full Set	MPCBS52
Combi Max Bottom Baffles	MPCBS52X

VORTEX PRO

15-21kW/Combi 21 Full Set	VBS93
15-21kW/Combi 21 Bottom Baffles	VBS93B
15-26kW/Combi 26 Full Set	VBS01
15-26kW/Combi 26 Bottom Baffles	VBS11
26-46kW/Combi 36 Full Set	VBS36
26-46kW/Combi 36 Bottom Baffles	VBS10
46-58kW Full Set	VBS76
58-70kW Full Set	VBS77



MPBS12X

VORTEX ECO

15-26kW Full Set	VBS96
15-26kW Bottom Baffle	VBS96A
26-35kW Full Set	VBS97
12-21kW Wallhung Full Set	WBS03
12-21kW Wallhung Bottom Baffle	WBS03A
Combi 26 XS (Pre 16) Full Set	VBS137
Combi 26 XS (Post 16) Full Set	VBS137A

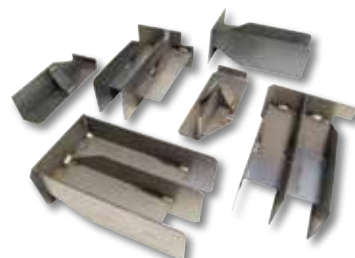

MPBS15

EUROFLAME

50/90 & 70/90 Full Set (Post 94)	EFBS09
50/70 Full Set	EFBS30
90/120 Full Set	EFBS49

MULTIPASS

50/70 Full Set	MPBS12
50/70 Bottom Baffles	MPBS12X
70/90 Full Set	MPBS13
70/90 Bottom Baffles	MPBS13X
90/110 Full Set	MPBS14
90/140 & 110/140 Full Set	MPBS15
90/140 & 110/140 Bottom Baffles	MPBS15X
140/160 Full Set	MPBS28
160/200 Full Set	MPBS27



MPBS15X

COMBUSTION ACCESS DOORS

Description	No
Euroflame 50/90, 70/90, 90/120	
Pre Nov 03	EFBS18
Post Nov 03	EFBS20
Combi 70 MKI, V3, Euroflame 50/70	
Pre Nov 03	EFBS18X
Post Nov 03	EFBS20X
Combi 90 MKII, V3	
Multipass 50/70, 50/90, 70/90	MPBS16
Multipass 90/110, 90/140	MPBS17
Multipass 140/200	MPBS17L
Vortex Pro Combi 21kW	MPCBS111A
Vortex Pro Combi 26kW	
Pre Dec 14	MPCBS110
Post Dec 14	MPCBS110A
Vortex Pro Combi 36kW	VBS69Z
Vortex Eco 15/26kW	VBS92
Vortex Pro 15/21kW	
Pre Nov 15	VBS94
Post Nov 15	VBS94A
Vortex Pro 15/26kW	
Vortex Eco 26/35kW	VBS69
Vortex Pro 26/46kW	VBS69X
Vortex Pro 46/70kW	VBS04
Vortex Eco W/H 12/21kW	WBS04



MPCBS16



EFBS20



VBS92

COMBUSTION DOOR SEALS

Description	No
Combi 90 MKII	
Combi 90 V3	TPBS23L
Multipass 50/90 & 90/140	
Multipass 140/200	TPBS24
Vortex Pro Combi 26kW	
Vortex Pro 15-26kW	VBS15
Vortex Eco 15-26kW	
Vortex Pro Combi 36kW	
Vortex Pro 26-46kW	VBS16
Vortex Eco 26-35kW	
Vortex Pro 46-70kW	VBS111
Vortex Eco Wallhung 12-21kW	WBS05



COMBI DIVERTER VALVE

Combi MKII
Combi V3



Valve No: **MPCBS20/A**
Circlip No: **MPCBS35**

DIAPHRAM KIT FOR DIVERTER VALVE

Combi MKII
Combi V3



No: **MPCBS33/A**

COMBI MICROSWITCH

Combi MKII
Combi V3



No: **MPCBS41**

THERMOSTATIC MIXING VALVE

Combi MKII, V3
Vortex Pro Combi



No: **MPCBS22F**

15 PLATE HEAT EXCHANGER

Combi MKII



No: **MPCBS21/A**

35 PLATE HEAT EXCHANGER

Vortex Pro Combi
Combi V3



No: **MPCBS53/A**

ORANGE RELAY

Vortex Pro
Combi External
(pre 08)



No: **MPCBS72X**

ORANGE RELAY BASE

Vortex Pro
Combi External
(pre 08)



No: **MPCBS75**

CLEAR RELAY

Vortex Pro
Combi
(pre 08)



No: **MPCBS72**

CLEAR RELAY BASE

Vortex Pro
Combi
(pre 08)



No: **MPCBS72B**

FLOW SWITCH



No: **WA1476**

TANK & BOILER CONTROL STAT



Stat No: **WA2131**
Knob No: **WA2166**

BOILER LIMIT STAT

Combi Models



No: **WA281**

TANK LIMIT STAT



No: **WA2126**

SECONDARY HEAT EXCHANGER GASKET



No: **WA3009**

DUAL-SAFE STAT

Non-Combi models



No: **WAWDS2**

CONDENSATE TRAP



No: **WA3780**

LOW PRESSURE SWITCH



No: **WA3529**

PLATE HEAT EXCHANGER



No: **WA599**

AUTO AIR VENT

Complete with check valve



No: **WA614**

PRESSURE RELIEF VALVENo: **WA2132****FILLING LOOP**No: **WA2133****PRESSURE GAUGE**No: **WA3019****MIXER VALVE**No: **WA1621****PCB CONTROLLER**

Mk IV

No: **WA2419****PRESSURE VESSEL 12 LITRE**Vessel No: **WA2128**Hose No: **WA2058****COMBI 90 120 TOP BAFFLE**

290 x 275mm

No: **WA015R-TOP****COMBI 90 120 MIDDLE BAFFLE**

290 x 275mm

No: **WA015R-MID****COMBI 90 120 BOTTOM BAFFLE**

290 x 275mm

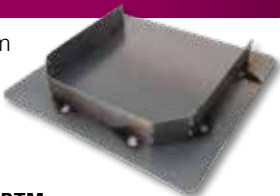
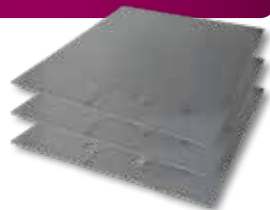
No: **WA015R-BTM****BAFFLE SET**380 x 408mm
22mm HolesNo: **WA013R**

BOILER CONTROL STAT



No: TR206896

BOILER CONTROL KNOB



No: TR206897

DHW CONTROL STAT



No: TR209850

BOILER LIMIT STAT



No: TR206892

TANK STAT



No: TR208096

BLOCKED FLUE STAT



No: TR45651

FLEXIBLE AIR INTAKE



No: TR209491

AIR INLET ASSEMBLY



No: TR221351

CLEANOUT DOOR SEAL (STRIP)

Colour may vary



No: TR208151

CLEANOUT DOOR SEAL (ROLL)

10 Metre



No: TR208151ROLL

EUROSTAR MIXING VALVE



No: TR208078

PRESSURE RELIEF VALVE

1/2" 3bar



No: TR208069

DIVERTER VALVE



No: TR222787

DIVERTER VALVE REPAIR KIT



No: TR222787/KIT

HYDRAULIC REPAIR KIT



No: TR222786

FLOW SWITCH



No: TR208651

EXPANSION VESSEL



No: TR207291

VESSEL HOSE

3/4"elb x 1/4"str
450mm length



No: TR207292

COTTON REEL IGNITOR



No: TR20202

AIR CONVEYOR



No: TR221349

BAFFLES



Pre April 2003

		Part No	No. Required
50/65	TOP	TR221651	1
	BOTTOM	TR221650	5
70/90	TOP	TR208838	3
	BOTTOM	TR208834	1
100/125	TOP	TR208866/A	2
	BOTTOM	TR208871/A	6
130/150	TOP	TR209293	1
	BOTTOM	TR209290	4
160/180	TOP	TR209287	2
	BOTTOM	TR209288	8
170/250	ALL THE SAME	TR203278	9

April 2003 Onwards

50/90	TOP	TR208834	1
	BOTTOM	TR208838	3
100/125	TOP	TR208866/A	2
	BOTTOM	TR208871/A	6
130/240	TOP	TR209282	2
	BOTTOM	TR209280	8



worcester official stockist

The spares you need,
when you need them.

We are a **Gold Level** Stockist with the
top 200+ core parts stocked here.

PJ BURNER GASKET



No: 87161409020

OIL HOSE KIT



No: 87161153110

ISO BULKHEAD VALVE 1/4"



No: 87161424230

ISO BULKHEAD VALVE 1/4"

Straight



No: 8716119692

PRESSURE RELIEF VALVE



No: 87161424160

PRESSURE GAUGE 1/8"

Fits Heatslave



No: 87161423580

HEATSLAVE DIVERTER ACTUATOR



No: 87161049200

HEATSLAVE DIVERTER VALVE BODY



No: 87161049190

DIVERTER VALVE CARTRIDGE



No: 87161051320

HEATSLAVE FLOW SWITCH

Complete assembly



No: 87161200690

HEATSLAVE PLATE HEAT EXCHANGER



No: **87161429060**

AUTO AIR VENT 3/8"



No: **87161405000**

HEATSLAVE PCB

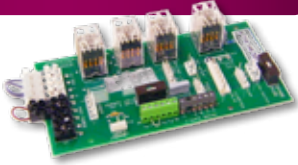

No: **87161463010**

HEATSLAVE RECTANGULAR VESSEL



Vessel No: **87161425050**

Hose No: **87161405070**

PROGRAMMER HIGHFLOW 400



No: **77161920070**

LIMIT STAT

Heatslave



No: **87161423100**

DANESMOOR POST PURGE UNIT

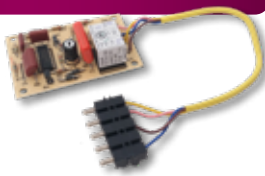

No: **87161463080**

HEATSLAVE GREEN CONTROL KNOB



No: **87161410870**

HOT WATER STAT

Heatslave



No: **87161423130**

BOILER CONTROL STAT

Heatslave
Danesmoor



No: **87161423090**

GREENSTAR DIVERTER ACTUATOR

Drayton



No: 87161087230

GREENSTAR DIVERTER VALVE BODY

Post 2009



No: 87186822900

GREENSTAR DIVERTER VALVE BODY

Pre 2009



No: 87161087220

CAMRAY FLOW SWITCH



No: 87161084010

CAMRAY ACTUATORS

HSA3CD

No: 87161083990



HSA3ND

No: 87161110860

TERMINAL GUARD



No: 7716190050

PUMP VALVE 22mm - 1 & 1/2"



No: 87161424170

GREENSTAR HEATSLAVE PCB



No: 87186852610

HEATSLAVE DIVERTER VALVE

V4044



No: 87161201310

HEATSLAVE WATER ISO VALVE



No: 87161424180

GREENSTAR HEATSLAVE VESSEL

12 litre



No: 87161076600

ROUND VESSEL

12 litre



No: 87161083890

CONTROL STAT

Camray
BBEL00230



No: 87161078720

LIMIT STAT

Camray
BBEL00215



No: 87161078710

GREENSTAR VESSEL HOSE



No: 87161124260

GREENSTAR FLOW SWITCH



No: 87161114060

GREENSTAR PROGRAMMER



No: 7716192033

**ABGO are profile stockists for
Worcester oil and gas
heating spares.**

**Please have the boiler serial
number to hand for
part matching.**



worcester
official
stockist

CONTROL STAT



No: **GB10016**

HIGH LIMIT STAT



No: **GB10017**

EXPANSION VESSEL 10LTR

Elbi
Opposite end
connections



No: **GB10002**

EXPANSION VESSEL 10LTR

Winkelmann
Same end
connections



No: **GB10003**

PLATE HEAT EXCHANGER



8" No: **GB10028A**
12" No: **GB10028S**

FLOW SWITCH



No: **GB10001**

PRESSURE RELIEF VALVE



No: **GB10011**

FROST STAT



No: **GB10018**

MIXER VALVE



No: **GB10000**

PRESSURE GAUGE



No: **GB10012**

BOILER CONTROL STAT

Statesman



No: 26009018

BOILER LIMIT STAT

Statesman
110°C



No: 26009097

EXPANSION VESSEL

Statesman

10 Litre Vessel
No: 26009157

Hose

No: 26009158



PLATE HEAT EXCHANGER

Statesman



No: 26009107

FLOW SWITCH

Statesman



No: 26009166

DIVERTER VALVE ASSEMBLY

Statesman



No: 26009160

PRESSURE/TEMPERATURE GAUGE

Statesman



No: 26009159

MIXER VALVE

Statesman



No: 26009148

CONTROL KNOB

Statesman



No: 26002014

INTEGRATED TIME SWITCH

Statesman



No: 10/19114



WALLSTAR CONTROL STAT



Condensing No: **EL023A**
Non-Condensing No: **EL023**

LIMIT STAT

110°C



No: **EL220**

COMBI EXPANSION VESSEL

10 Litre



No: **SYS010**

NON RETURN VALVE

1/4"



No: **BSUFK-3**

COMPLETE MANIFOLD ASSEMBLY



No: **COM012**

WALLSTAR DIVERTER VALVE KIT

Heating Side



Divertor Kit No: **COM423**
Diaphragm Kit No: **COM424**

MICRO SWITCH ASSEMBLY



No: **EL040**

WALLSTAR MIXER VALVE

Complete with pipes



No: **COM011**

PRESSURE RELIEF VALVE



No: **COM301**

OIL LINE & FILTER



No: **BS099A**

BOILER CONTROL STAT



No: **CK1568002**

HIGH LIMIT STAT

Manual Reset



No: **CK1568004**

EXPANSION VESSEL



10 Litre Vessel

No: **CY1541029**

12 Litre Vessel

No: **CC1568006**

PLATE HEAT EXCHANGER

15-41kW



No: **CC1541007**

FLOW SWITCH



No: **CC1568003**

CONTROL KNOB & BEZEL



No: **CK1568001**

PRESSURE GAUGE



No: **CC1568007**

MIXER VALVE



No: **CC3065MIX**

PRESSURE RELIEF VALVE



No: **cc1568008**

CONDENSE TRAP

Includes Bracket



No: **CTR005**



**LOW
NOx**

**The only oil boiler
with a Which?
Best Buy for the
second year running.**

#MustBeVortex

**VORTEX PRO UTILITY
RANGE**

Tried & trusted Riello
Low NOx burner
technology

Awarded the coveted
Which? Best Buy for the
second year running

Internal & external
models with outputs
from 15-70kW

Exceptional seasonal
efficiency of up to
93.3%**

Also available in the
Vortex Range:

- VortexBlue**
- Vortex Eco**
- Vortex Boiler House**

Up to
5 year
guarantee*



www.grantuk.com



* Subject to full T&C's and status ** SAP 2009



Oil Appliances

GRANT OIL CONDENSING BOILERS

An award winning, tried and tested oil-fired boiler range

The name 'Grant' has in recent years become synonymous with highly efficient oil-fired central heating appliances. Designs like the 'Multi Pass' boiler achieved efficiency levels far in excess of any UK or European Standards and have helped thousands of homes to reduce their annual fuel bills. So it will come as no surprise to see Grant yet again leading the way with the Grant Vortex oil-fired condensing boiler range with exceptional SAP2009 efficiencies up to 93.3% gross (97% gross for SAP2005). Grant's ultra-high efficiency condensing oil boiler range has been on the market for over 15 years and now features 63 different model variations, with outputs ranging from 12 - 70kW (50,000 - 240,000 Btu/h).



What is a condensing oil boiler?

Condensing boilers differ from traditional boilers in that they are designed to capture heat normally lost through the flue system during the combustion process. Unlike traditional oil-fired boilers the Grant Vortex condensing boiler has a built-in stainless steel heat exchanger incorporating Grant's unique turbulator baffle system, which cools the gases to a point where the latent heat, normally lost to the atmosphere through the flue, can be usefully extracted. The additional energy recovered enables the boiler to operate continuously at much higher efficiency levels, resulting in lower heating and hot water running costs.

Easy to commission, service and maintain

As with all oil-fired appliances, Grant Vortex Condensing Oil Boilers require commissioning at the time of installation. This simple process ensures that the boiler is working at peak efficiency which, in turn, will result in lower running costs and long term reliability. Annual maintenance is also made easy by Grant's cleverly designed front service access to both the burner and all the internal serviceable parts. This feature enables Grant Vortex Condensing Boilers to be fitted neatly and unobtrusively within either the kitchen or utility room environment. Alternatively, if internal siting is problem, space-saving outdoor versions are available.

The innovative VortexBlue Range

As part of its dedication to cleaner energy, Grant introduced the Grant VortexBlue range which combines its proven condensing boiler technology with a revolutionary new blue flame. Using a new state-of-the-art Riello Blue Flame compact burner alongside the familiar Vortex oil-fired-boiler, this market-leading combination gives you an easy to install, reliable product with those all-important low emissions.



VORTEX ECO UTILITY RANGE

The Grant Vortex Eco Utility range was launched as a direct response to customer demand for a competitively priced condensing boiler.

The Eco models incorporate the latest version of the Grant Vortex stainless steel heat exchanger. Out-puts range between 15kW and 35kW (50-120,000Btu/h) with SAP 2009 gross seasonal efficiencies of 90.3 - 90.8% gross.

As you would expect from a product with this pedigree, Grant Vortex Eco Utility boilers are exceptionally quiet in operation and feature the latest Riello burner technology. The boilers also have a simplified casing, control panel and pipework arrangement, making them the ideal choice for utility room installations. All standard Eco Utility boilers are designed to allow the burner and combustion chambers to be serviced from the front, however, models fitted with a sealed system kit require top service access.



No	Description
VTXECO15/21	Vortex ECO Utility Internal 15/21 kW
VTXECO21/26	Vortex ECO Utility Internal 21/26 kW
VTXECO26/35	Vortex ECO Utility Internal 26/35 kW

VORTEX ECO WALL HUNG RANGE

Available in outputs ranging from 12-21kW, in both sealed system and open-vented system variants, these new appliances are pre plumbed and encompass Grant's patented Vortex stainless steel heat exchanger and turbulator baffle system. All internal models require a separate flue kit (not supplied with the boiler) and are compatible with all Grant EZ-Fit low level, high level and vertical flue systems, so now almost any installation situation can be catered for.



No	Description
VTXOMWH12/16	Vortex ECO External Wall Hung 12/16 kW
VTXOMWH16/21	Vortex ECO External Wall Hung 16/21 kW
VTXSOMWH12/16	Vortex ECO External System Wall Hung 12/16 kW
VTXSOMWH16/21	Vortex ECO External System Wall Hung 16/21 kW
VTXSWH12/16	Vortex ECO Internal System Wall Hung 12/16 kW
VTXSWH16/21	Vortex ECO Internal System Wall Hung 16/21 kW
VTXWH12/16	Vortex ECO Internal Wall Hung 12/16 kW
VTXWH16/21	Vortex ECO Internal Wall Hung 16/21 kW

VORTEX ECO OUTDOOR RANGE

Today, as around one in four oil boiler installations are external, Grant have expanded the number of options available with the launch of three competitively priced Eco External modules. The models have outputs between 15kW and 35kW (50-120,000Btu/h) and SAP 2009 gross seasonal efficiencies of 90.3 - 90.8% gross. Grant's wall hung oil-fired boiler range comprises four internal and four external models.

No	Description
VTXOMECO15/21	Vortex ECO External 15/21 kW
VTXOMECO21/26	Vortex ECO External 21/26 kW
VTXOMECO26/35	Vortex ECO External 26/35 kW



VORTEX PRO OUTDOOR RANGE

All Pro External modules enjoy the same unique features as the Eco External modules including the factory fitted multi-directional flue, high quality external powder coated casing, built in frost protection, mains isolating switch and a test switch.

However, in addition, the boilers have a higher efficiency level and are factory wired to receive an 'optional' RF (radio frequency) wireless programmer. In this situation, the receiver can be plugged into the control panel of the module, enabling the boiler to be operated using a remote controller from any room inside the house, without the need for hard wiring.

No	Description
VTXOM15/21	Vortex PRO Outdoor 15/21 kW
VTXOM15/26	Vortex PRO Outdoor 15/26 kW
VTXOM26/36	Vortex PRO Outdoor 26/36 kW
VTXOM36/46	Vortex PRO Outdoor 36/46 kW
VTXOM46/58	Vortex PRO Outdoor 46/58 kW
VTXOM58/70	Vortex PRO Outdoor 58/70 kW



VORTEX PRO BOILER HOUSE RANGE

The new Grant Vortex Boiler House models come in a distinctive powder coated casing in our iconic Grant red and feature an externally mounted Riello RDB burner and dual thermostat. They have high energy efficiency ratings which not only significantly lower fuel bills but also considerably reduce greenhouse gas emissions and lessen the environmental impact of domestic hot water and heating systems.

The Grant boiler House models are ideal for locations that are difficult to access like cellars or plant rooms, where a white cased utility version is not always the best solution. The Boiler House models encompass the same unique stainless steel heat exchangers used in other Vortex boilers together with Grant's exclusive turbulator baffle system which provides ultra-high efficiency and low running costs. These additions to the Vortex range are compatible with all Grant EZ-Fit Flue systems and are flued in exactly the same way as Utility models, further enhancing installation options.

No	Description
VTXBH15/21	Vortex PRO Boiler House 15/21 kW
VTXBH21/26	Vortex PRO Boiler House 21/26 kW
VTXBH26/35	Vortex PRO Boiler House 26/35 kW
VTXBH36/46	Vortex PRO Boiler House 36/46 kW
VTXBH46/58	Vortex PRO Boiler House 46/58 kW
VTXBH58/70	Vortex PRO Boiler House 58/70 kW



VORTEX PRO KITCHEN UTILITY RANGE

The Grant Vortex Pro Kitchen/Utility range has been upgraded to enable a number of new programmer options to be used with the appliance. A plug-in programmer (Product code: EPKIT) can be installed within the fascia, or alternatively, the receiver for Grant's new wireless RFT Kit (Product code: RFTKIT) can be located within the knockout and the programmer sited conveniently within the building. The boilers have very high SAP 2009 gross seasonal efficiencies of between 90.7 - 93.3% and feature the 'award winning' unique Grant Vortex stainless steel condensing heat exchanger, and turbulator baffle system. The 15-21 utility model has been designed to fit within a kitchen unit and, due to its reduced width, can be used as a direct replacement for most older oil-fired boilers.



No	Description
VTX15/21	Vortex PRO Kitchen/Utility 15/21 kW
VTX15/26	Vortex PRO Kitchen/Utility 15/26 kW
VTX26/36	Vortex PRO Kitchen/Utility 26/36 kW
VTX36/46	Vortex PRO Kitchen/Utility 36/46 kW
VTX46/58	Vortex PRO Kitchen/Utility 46/58 kW
VTX58/70	Vortex PRO Kitchen/Utility 58/70 kW
VTXS15/26	Vortex PRO Kitchen/Utility System 15/26 kW
VTXS26/36	Vortex PRO Kitchen/Utility System 26/36 kW
VTXS36/46	Vortex PRO Kitchen/Utility System 36/46 kW

VORTEX PRO COMBI RANGE

Grant Vortex Pro Combi features much larger heat exchangers which, due to their low water content and larger surface area, vastly increase the hot water performance available and mixing valves are pre-set at 50°C, controlling accurately the hot water draw off temperature from the boiler. They also feature a low system pressure cut off switch, enabling the combi to protect itself in the unlikely event of system water loss. Additionally, there are two very accurate electronic temperature controls which allow the boiler to operate in condensing mode on central heating, whilst maintaining its instant hot water production.



No	Description
VTXCOMBI21	Vortex PRO Internal Combi 21 kW
VTXCOMBI26	Vortex PRO Internal Combi 26 kW
VTXCOMBI36	Vortex PRO Internal Combi 36 kW
VTXOMCOMBI21	Vortex PRO External Combi 21 kW
VTXOMCOMBI26	Vortex PRO External Combi 26 kW
VTXOMCOMBI36	Vortex PRO External Combi 36 kW



VORTEXBLUE INTERNAL RANGE

The Grant VortexBlue combines our proven condensing boiler technology with a revolutionary new blue flame. Using a new state-of-the-art Riello Blue Flame compact burner alongside the familiar Vortex oil-fired boiler, this market-leading combination gives you an easy to install, reliable product with those all-important low emissions. The Grant VortexBlue internal models combine our existing proven condensing boiler technology with the latest Riello RDB BLU compact burner. The boilers feature a sleek white casing, unique control panel with neon diagnostic indicators and simplified pipework arrangement, making them the ideal choice for utility room installations.



No	Description
VTXBF21	VortexBlue Internal 15/21 kW
VTXBF26	VortexBlue Internal 21/26 kW
VTXBF36	VortexBlue Internal 26/36 kW
VTXSBF21	VortexBlue Internal Sealed System 15/21 kW
VTXSBF26	VortexBlue Internal Sealed System 21/26 kW
VTXSBF36	VortexBlue Internal Sealed System 26/36 kW

VORTEXBLUE COMBI RANGE

The intelligent VortexBlue Combi incorporates the latest Riello RDB BLU burner technology and combines it with our award winning Vortex stainless steel heat exchanger. The Grant VortexBlue Combi features large heat exchangers which, due to their low water content and larger surface area, vastly increased the hot water performance. With a low system pressure cut off switch, the combi protects itself in the unlikely event of system water loss.



No	Description
VTXBFCOMBI21	VortexBlue Combi 21 kW
VTXBFCOMBI26	VortexBlue Combi 26 kW
VTXBFCOMBI36	VortexBlue Combi 36 kW
VTXSBFOMCOM21	VortexBlue Internal Sealed System 15/21 kW
VTXSBFOMCOM26	VortexBlue Internal Sealed System 21/26 kW
VTXSBFOMCOM36	VortexBlue Internal Sealed System 26/36 kW

VORTEXBLUE EXTERNAL RANGE

The Grant VortexBlue external modules have some of the highest oil-fired boiler efficiencies available today. These models are ideal for situations where a white cased kitchen/utility version is not always the best solution, possible due to limited space within the home.

All modules include a factory fitted multi-directional flue, high quality external powder coated casing, built in frost protection, mains isolating switch and a test switch.

Just as other VortexBlue boilers, this range also incorporates Riello's RDB Blu burner technology teamed with our patented Vortex stainless steel heat exchanger.



No	Description
VTXBFOM21	VortexBlue External 15/21 kW
VTXBFOM26	VortexBlue External 21/26 kW
VTXBFOM36	VortexBlue External 26/36 kW



Grant UK Installer Scheme

Join this growing network of heating engineers and benefit from the wide range of opportunities this installer scheme has to offer.

- Extended product guarantees of up to 10 years
- Exclusive access to G1 Portal and G1 Click app
- Company profile on Grant UK website

Full Terms & Conditions apply for Scheme membership and extended guarantees

www.grantuk.com



INTERNAL HEAT ONLY BOILERS

- Low NOx and Blue Flame options available
- Compact design – fits under standard kitchen worktop (outputs up to 35kW)
- Fully insulated and acoustically designed for ultra-quiet operation
- PCB controller using highly accurate thermistors with anti-cycling function (outputs up to 35kW)*
- Front service access
- Multi-directional flue options
- High performance Low NOx and Blue Flame burners complete with full diagnostic control box



ERP Rating



Envirogreen™	No.	Output	Efficiency	Weight
Kitchen 12-18	EGE018KIT	12-18kW	95.2 %	115 kg
Kitchen C20	EGE020KIT	20kW	94.8 %	125 kg
Kitchen C26	EGE026KIT	26kW	94.8 %	128 kg
Kitchen C35	EGE035KIT	35kW	94.4 %	131 kg
Kitchen C44	EGE044KIT	44kW	93.6 %	210 kg
Kitchen C58	EGE058KIT	58kW	92.7 %	216 kg
Kitchen C73	EGE073KIT	73kW	92.0 %	242 kg
Commercial Utility C100	EGE100KIT	100kW	n/a	390 kg

EnviroLite™	No.	Output	Efficiency	Weight
Utility CR20	EGE020UTL	12-20kW	93.8 %	125 kg
Utility CR26	EGE026UTL	20-26kW	93.7 %	128 kg
Utility CR35	EGE035UTL	26-35kW	92.9 %	131 kg

EXTERNAL HEAT ONLY BOILERS

- Low NOx and Blue Flame options available
- Compact design – fits under standard kitchen worktop (outputs up to 35kW)
- Fully insulated and acoustically designed for ultra-quiet operation
- PCB controller using highly accurate thermistors with anti-cycling function (outputs up to 35kW)*
- Front service access
- Multi-directional flue options
- High performance Low NOx and Blue Flame burners complete with full diagnostic control box



ERP Rating



Envirogreen™	No.	Output	Efficiency	Weight
Heatpac 12-18kW	EGE018HPK	12-18kW	95.2 %	134 kg
Heatpac C20	EGE020HPK	20kW	94.8 %	154 kg
Heatpac C26	EGE026HPK	26kW	94.8 %	154 kg
Heatpac C35	EGE035HPK	35kW	94.4 %	158 kg
Heatpac C44	EGE044HPK	44kW	93.6 %	244 kg
Heatpac C58	EGE058HPK	58kW	92.7 %	250 kg
Heatpac C73	EGE073HPK	73kW	92.0 %	280 kg

Envirogreen™	No.	Output	Efficiency	Weight
Slimline Heatpac C20	TBC	20kW	93.0 %	147 kg
Slimline Heatpac C26	TBC	26kW	93.0 %	150 kg
Slimline Heatpac C35	TBC	5kW	92.0 %	153 kg

EnviroLite™	No.	Output	Efficiency	Weight
Heatpac CR20	EGE020SGV	12-20kW	93.8 %	131 kg
Heatpac CR26	EGE026SGV	20-26kW	93.7 %	154 kg
Heatpac CR35	EGE035SGV	26-35kW	92.9 %	158 kg

BOILERHOUSE REGULAR BOILERS

- Low NOx and Blue Flame options available
- Constructed using premium quality steel
- Fully insulated casing minimises heat loss
- PCB controller using highly accurate thermistors with anti-cycling function (outputs up to 35kW)*
- Multiple tapping points for ease of installation
- Patented heat exchanger design
- Multi-directional flue options
- High performance Low NOx and Blue Flame burners complete with full diagnostic control box
- Models available in outputs of 12kW to 100kW



ERP Rating



EnviroLite™	No.	Output	Efficiency	Weight
Boilerhouse CR20	EGE020SBH	20kW	93.8 %	107 kg
Boilerhouse CR26	EGE026SBH	26kW	93.7 %	112 kg
Boilerhouse CR35	EGE035SBH	35kW	92.9 %	115 kg

Envirogreen™	No.	Output	Efficiency	Weight
Popular 12-18kW	EGE018POP	12-18kW	95.2 %	99 kg
Popular C20	EGE020POP	20kW	94.8 %	107 kg
Popular C26	EGE026POP	26kW	94.8 %	112 kg
Popular C35	EGE035POP	35kW	94.4 %	115 kg
Popular C44	EGE044POP	44kW	93.6 %	182 kg
Popular C58	EGE058POP	58kW	92.7 %	190 kg
Popular C73	EGE073POP	73kW	92.0 %	210 kg
Popular C100	EGE100POP	100kW	n/a	300 kg

INTERNAL SYSTEM BOILERS

- Low NOx and Blue Flame options available
- Compact design – fits under standard kitchen worktop (outputs up to 35kW)
- Fully insulated and acoustically designed for ultra-quiet operation
- PCB controller using highly accurate thermistors with anti-cycling function (outputs up to 35kW)
- Factory-fitted expansion vessel and circulating pump
- Multi-directional flue options
- High performance Low NOx and Blue Flame burners complete with full diagnostic control box



ERP Rating



Envirogreen™	No.	Output	Efficiency	Weight
System C20	ESE020DLX	20kW	94.8 %	143 kg
System C26	ESE026DLX	26kW	94.8 %	146 kg
System C35	ESE035DLX	35kW	94.4 %	149 kg
System C44	ESE044DLX	44kW	93.6 %	235 kg

EXTERNAL SYSTEM BOILERS

Envirogreen™	No.	Output	Efficiency	Weight
Systempac C20	ESE020NKT	20kW	94.8 %	163 kg
Systempac C26	ESE026NKT	26kW	94.8 %	163 kg
Systempac C35	ESE035NKT	35kW	94.4 %	166 kg
Systempac C44	ESE044NKT	44kW	93.6 %	270 kg
Slimline Systempac C20	ESE020SLM	20kW	93.0 %	147 kg
Slimline Systempac C26	ESE026SLM	26kW	93.0 %	150 kg
Slimline Systempac C35	ESE035SLM	35kW	92.0 %	153 kg

INTERNAL COMBI BOILERS

- Low NOx and Blue Flame options available
- Excellent hot water performance
- Rapid reheat after hot water draw-off
- Standard and Slimline models
- Fully insulated and acoustically designed for ultra-quiet operation
- Durable casings with a high-quality finish
- PCB controller using highly accurate thermistors
- Front service access
- Multi-directional flue options
- High performance Low NOx and Blue Flame burners complete with full diagnostic control box



ERP Rating



Envirogreen™	No.	Output	DHW Flow	Efficiency	Weight
Combi HE C20	ECE020DLX	20kW	16 ltr/min	93.0 %	167 kg
Combi HE C26	ECE026DLX	26kW	16 ltr/min	93.0 %	170 kg
Combi HE C35	ECE035DLX	35kW	20 ltr/min	93.0 %	173 kg
Slimline Combi C20	ECE020SLM	20kW	12-14 ltr/min	92.5 %	165 kg
Slimline Combi C26	ECE026SLM	26kW	16 ltr/min	92.5 %	168 kg
Slimline Combi C35	ECE035SLM	35kW	16 ltr/min	91.0 %	172 kg

EXTERNAL COMBI BOILERS

The Firebird ranges of external Combi Boilers are similar in specification to their equivalent internal models, with the addition of a built-in frost thermostat.

There is no requirement to house the boiler in a building, so this option provides an ideal solution if internal space is at a premium.

The boilers have removable sides for ease of access to any part of the unit.

Piping can be carried out from the back or from underneath.



ERP Rating



Envirogreen™	No.	Output	DHW Flow	Efficiency	Weight
Combipac HE C20	ECE020CPK	20kW	16 ltr/min	92.0 %	200 kg
Combipac HE C26	ECE026CPK	26kW	16 ltr/min	92.0 %	200 kg
Combipac HE C35	ECE035CPK	35kW	20 ltr/min	91.6 %	203 kg

FRANCO BELGE



OIL STOVES, THE SMART OPTION

- **Clever** - They look and feel like a wood burning stove but without the work involved cutting logs and their storage. An oil tank is all you need.
- **Clean** - No carrying wood into the house and ash out with all the resulting mess that can cause. No unexpected wildlife taking up residence in your home.
- **At over 75% efficiency** they can cost as little as £2.04 per day to run (Belfort - based on 50p per litre).
- **They require no electricity to run.** Once lit the gravity oil flow will keep it burning, so even in a power cut you are guaranteed a warm room in your home.
Open the door to the room and let the stove heat a greater area. They come as standard with Franco Belge's unique ignition system allowing simple, no mess, lighting.



- **Designed to provide a continuous source of background heating** with the ability to increase the heat output at the turn of a dial. The result is less temperature variation, which minimises cold draughts, and because

it never has to heat the house from cold a smaller heat output is required from the stove than would be required from a cycling system or wood burning stove to heat a similar area.

- **Low maintenance.** The Franco Belge vaporising burner pot burns so efficiently that carbon deposits are kept to a minimum. The operation of a simple de-coking rod on the inlet for the oil into the burner is all that is required during the heating season. Like all heating appliances a yearly service by an OFTEC engineer is required.
- **Peace of mind.** ABGO's experienced technical team are available to answer any questions you may have. Spare parts are not an issue either and with nearly 50 years of supplying the heating industry throughout the UK you will never be let down.

BELFORT

Fuel Type	Oil
Nominal Heat Output	5kW
Efficiency	80%
Flue Outlet ID (Top or Rear)	100mm / 4"
Weight	68kg
H / W / D	558 / 420 / 530mm
No.	FB1740506

SAVOY

Fuel Type	Oil
Nominal Heat Output	8kW
Efficiency	80%
Flue Outlet ID (Top or Rear)	125mm / 5"
Weight	100kg
H / W / D	660 / 535 / 554mm
No.	FB1740707

BURGUNDY

Fuel Type	Oil
Nominal Heat Output	10kW
Efficiency	81%
Flue Outlet ID (Top or Rear)	125mm / 5"
Weight	118kg
H / W / D	760 / 620 / 544mm
No.	FB1741059

OPTIONAL COAL OR LOG EFFECT KITS

Type of Effect	No.
Log Effect	FB10922
Coal Effect	FBCE103



SALES COUNTER NOW OPEN

PART MATCHING FOR ALL GAS BOILERS, FIRES, COOKERS, HEATERS AND CYLINDERS!



GAS

GAS APPLIANCE SPARES

Unit 1 Sidings Close
Wolverhampton WV11 3DR
Open weekdays 7:30 - 5:30pm
Saturdays 8:00 - 12:00pm (Winter Only)

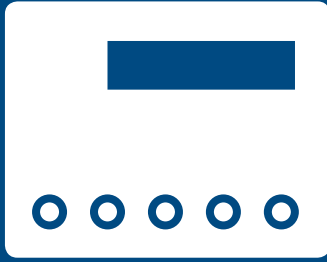

Heating Controls

22mm Motorized
3 Port Valves

22mm Motorized
2 Port Zone Valves

Full Programmers
7day 5/2day 24hr

Full Timeswitches
7day 5/2day 24hr

Wireless Programmable
Room Stat Packs

Wireless
Room Stats

Programmable
5/2day Room Stats

DANFOSS

HS3
087N661300



HP22
087N660900



FP715Si
087N789800



TS715Si
087N789900



TP5000SiRF & RX1
087N791400



RETRF & RX1
087N727600



TP5000Si
087N791000



DRAYTON

MA1679-3



ZA5/679-2



LP241
LP522
LP722



LP111
LP711



RF700 Digistat Plus2RF
RF701 Digistat Plus3RF



RF601
Digistat Plus Room Stat



22084 Digistat Plus
22083 Digistat Plus



HONEYWELL



V4073A1039



V4043H1056



ST9400C1000
ST9500C1015



ST9100A1008
ST9100C1006



CMT721D1019
CMT921A1042



DT92E
Y6630D1007



CMT701A1014
CMT907A1041

SIEMENS



CMV322



CZV222



RWB29Si
RWB2007



RWB27Si
RWB1007



RDJ10RF
REV24RF



RDH10RF



REV24RF

SUNVIC



SDV2211



SZV2212



SunPro2000



SunPro1000



TLXRFV
SunStatRF



TLX1010
TLX1012



SunStat

HONEYWELL SYNCHRON MOTOR

240V



No: **40002737003/U**

DRAYTON SYNCHRON MOTOR

240V



No: **28670**

UNIVERSAL SYNCHRON MOTOR

240V



No: **SYNCHRON**

HONEYWELL BALL & PLATE



No: **40003918007/U**

ELECTRONIC TIME SWITCH

EP1 Electronic Timeswitch - Replacement for older EP4000, EP4002, EP5002 Models

- Potterton EP1 Single Channel Timeswitch
- Up to Three on/off periods per day.
- Digital Clock Display.
- Independent 7 day programming.
- Fully pumped and gravity heating systems.
- Battery backup in the event of power failure.
- Dimensions: 104x161x49 HxWxD
- Common Base Plate To EP Range.

No: **7211472**



ELECTRONIC PROGRAMMER - 2 CHANNEL

EP2 Electronic Programmer - Replacement for older EP2000, EP2001, EP2002, EP3002, EP6002 Models

- Potterton EP2 Twin Channel Programmer for controlling Central Heating & Hot Water.
- Suits both fully pumped and gravity heating systems.
- Digital Clock Display.
- Up to Three on/off periods per day.
- LED Circuit Indicators.
- Independent control of heating or hot water.
- Common Base Plate To EP Range of Programmers
- Clock Maintained During Power Failure
- Dimensions: 104x161x49mm HxWxD

No: **7211473**



The one to fit, where others don't.

The new MagnaClean Atom is a super compact, space saving filter, developed to provide effective magnetic filtration in the tightest of installation spaces.

The slip socket designs allows for installation in just under two minutes and with horizontal servicing 115mm is the total space required.



2 minute installation



Bypass 180 degree



Vertical and horizontal installation



Fits in the tightest of spaces



Space saving for simple servicing

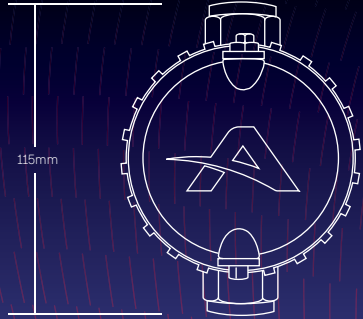

MagnaClean™ Atom

Small space. Big idea.

www.adey.com/atom

THE GAME CHANGER

MagnaClean® Professional3 Sense

DEFINING THE FUTURE OF WATER TREATMENT

www.adey.com/pro3

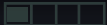

THE FILTER THAT **CONNECTS DIRECTLY TO YOUR SMARTPHONE** ALLOWING VISIBILITY OF YOUR CUSTOMERS HEATING SYSTEMS.



01.

Start with your room thermostat for central smart control



02.

Then add radiator thermostats



03.

Continue to add radiator thermostats in each room

Smart rooms with Wiser

Wiser can offer complete home personalisation by allowing you to control the temperature and schedule in each room independently.

It makes ultimate comfort affordable. Start with a smart room thermostat and build a full multi-room system over time.

This simple upgrade can have a huge impact on your comfort, convenience and energy bills.



Smart heating & hot water control



User friendly smartphone app



Individual room control



Eco Mode to maximise savings



Works with Amazon Alexa



Set different temperatures in selected rooms





SINGLE CHANNEL THERMOSTAT KIT



No: **WT714R9K0902**

TWO CHANNEL THERMOSTAT KIT



No: **WT724R9K0902**

THREE CHANNEL THERMOSTAT KIT



No: **WT734R9K0902**

SMART PLUG



No: **WB704H1A0902**

SMART MULTI-ZONE THERMOSTAT KIT 1



No: **WV714R9K0902**

SMART MULTI-ZONE THERMOSTAT KIT 2



No: **WV724R9K0902**

ROOM THERMOSTAT



No: **WN704R0S0902**

SMART RADIATOR TRV



No: **WV704R0A0902**



T6 SMART THERMOSTAT

Touch-screen interface.

Location features determine when your home is vacant or when you are on your way home adjusting the temperature automatically.

Features a choice of schedule settings to fit your lifestyle, including 7 day, 5/2 day and single day scheduling with up to 6 different time settings per day.

T6 Wired No: **Y6H910WF1011**

Decor Plate No: **ACC400**

T6R Wireless No: **Y6H910RW4022**



C1 Wi-Fi SECURITY CAMERA

Live stream of your home in wide-angle 720p HD with 5x digital zoom & night vision.

Get rapid notifications and clips of any unusual activity sent to your smart device.

No: **HAWCIC1S**



C2 Wi-Fi SECURITY CAMERA

See the bigger picture in 1080P HD with 145° wide-angle view and 6x digital zoom.

The camera turns off and on automatically, depending on your location (geofencing)

No: **HAWCIC2S**



evohome

Ok Google, set my living room to 21°C

Google Home



EVOHOME

Wireless and expandable zoning thermostat for your home.

Touch-screen interface.

Learns exactly how long your property takes to heat up. The right temperature in the right place at the right time.

Use your mobile to monitor and control your heating anytime from anywhere.

Upgrading your basic thermostat control to evohome smart zoning could save you up to 40% on your annual energy bills.

Designed for gas, fuel, wood and electric boilers. Heat-pump. Zone valve.

Radiators or under floor heating when zoning.

Simply connect it to your Wi-Fi network and download the app from the Apple store or Google play store.



Starter Pack No: **ATP921R3100**

Hot Water Kit No: **ATF500DHW**

MULTIZONE TRV KIT



No: **HR924UK**

MULTIZONE TRV



No: **HR92UK**



- Three constant curves/constant speed curves
- Two proportional-pressure curves
- Two constant-pressure curves
- Low EEI (Energy Efficiency Index)
- Deblocking device
- Alarm and warning indication
- Low noise level



Built on a platform proven in millions of boilers, the new UPS3 combines increased energy efficiency, an easier to wire plug and on board diagnostics with stalwart features such as ceramic bearings and shafts, a manual deblocking port and robust start-up functionality.

Plus, clever design means the new UPS3 can be used not only in system installations but also inside many of the UK's domestic boilers. Simply scan the old pump with the new Grundfos GO Replace smartphone app and it will tell you if the UPS3 is a compatible fit. That gives you the chance to fix even integrated pump issues in one visit, saving you time and your customer money.

No: **99199622**

PUMP VALVES

PFEXT25 Water Pump Extension 25mm

PFEXT45 Water Pump Extension 45mm

PFGATE22 Water Pump Gate Valve 22mm

PFGATE28 Water Pump Gate Valve 28mm

PFNUT Replacement Nut

PFWASHER Replacement Washer





Tools & Consumables

ABZORB SPILLAGE KIT

Perfect kit for cleaning up oil spills upto 25 litres.

- Abzorb oil eater
- 1 metre absorbent snake
- 250ml bottle of Abxtract cleaner
- Gloves, safety goggles and Supazorb wipes

No: **A06-0006**



SWEET AIR SPRAY

Oil Neutraliser
Cherry scented
CFC free



No: **C04-60-520**

ENVIRONMENTAL OIL CLEANER

For all those oil
spills and stains



No: **C04-60-200**

CHERRY BOMB

Just leave it near the
boiler or in your van
to remove oil odours



No: **C04-60-621**

ODOUR ELIMINATOR SPRAY

Heavy Duty Neutralizer



No: **C04-60-215**

PURE AIR

Suitable for turning
all nasty smells into
pure air



No: **C04-60-225**

SWEET AIR POWDER

For instant deodorization
leaving a pleasant cherry
smell



No: **C04-60-620**

SOOT REMOVER

Place into the combustion
chamber to remove
all soot and tar
effortlessly



No: **C04-35-515**

EOGB WATER DETECTING PASTE

A simple method to
check for water in
the oil tank



No: **C04-60-406**

FUEL SPILL SPONGE

Soaks up oil by turning into a rubber mat.
Bio-degradable

No: **C04-60-205**



'SUCK-IT' ABSORBENT MAT

Absorbs water, oil & other liquids

No: **S07-0002**



ENGINEERS SERVICE MAT

Water, dirt & oil resistant.
Place under boilers or radiators.

No: **REG-M38**

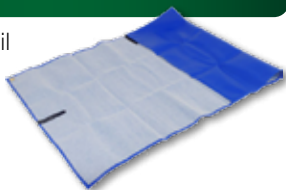

DUSTSHEET

Extra Heavy
12ft x 9ft

No: **DUSTSHEET**



ENGINEERS GENERAL SPILL KIT 9L

Soaks up oil & water.
Contains 5 pads,
1 cushion & bag tie

No: **3011008**



KIMBERLY CLARK PAPER TOWELS

2x Ply Paper Roll 10"
Steel Blue

No: **KIMWIPE**



AMBERSIL TOUGH WIPES

Heavy duty wipes
to remove oil & grease

No: **TOUGHWIPE**



REGIN HAND WIPES

Highly absorbent dual
sided textured wipes

No: **REG-W50**



ULTRA GRIME WIPES

100 Pack

No: **UGWIPES**



RE-USEABLE OVERSHOES

Size 10 No: **3010950**

Size 10½ No: **3010951**

Size 11 No: **3010952**

Size 11½ No: **3010953**

Size 12 No: **3010954**



LATEX GLOVES



No: **GLN703** - Medium
 No: **GLN704** - Large
 No: **GLN705** - Extra Large

BLACK MAMBA GLOVES



Pack of 100
 No: **3010992** - Medium
 No: **3010993** - Large
 No: **3010994** - Extra Large

EBONY NITRILE GLOVES



Pack of 100
 No: **EB702** - Small
 No: **EB703** - Medium
 No: **EB704** - Large
 No: **EB705** - Extra Large

SWARFEGA HAND CLEANER



500ml
 No: **DETUF500**

3 PIECE FLUE BRUSH KIT



1" x 500mm
 2" x 500mm
 3" x 900mm
 No: **REG-T56**

7 PIECE FLUE BRUSH KIT



5" & 12" Handles
 2x 12" Extensions
 50mm Round Head (L)
 50mm Round Head (S)
 50mm Flat Head
 No: **REG-T51**

3 PIECE FLUE BRUSH KIT



5/8" x 500mm Round
 2" x 500mm Flat
 2" x 500mm Round
 No: **REG-T55**

BOA BRUSH



24" Long Handle
 6" Long Head
 2" Diameter
 No: **595012**

HENRY VACUUM CLEANER



"HENRY" Vacuum
 with Cable Rewind,
 including A1 Kit

Standard No: **HVR200-M**
 Metal No: **NQS-250-21-AS1**

VAC BAGS



No: **604015-1CH**
 No: **604016-2BH**
 No: **604017-3B**
 No: **604019-4B**
 No: **604020-5B**

CLOSURE PLATE TAPE

50m Roll
Black



No: **REG-J75**

ALUMINIUM FOIL TAPE

45m Roll
45mm Wide



No: **REG-J70**

BROWN OIL TAPE

33m Roll



No: **REG-A07**

PTFE TAPE

12 Metre Roll



No: **PTFE**

GAS TAP GREASE

Molycote



No: **REG-Z15**

SILICONE GREASE

50g WRC Approved



No: **REG-Z40**

DUAL X BOILER CLEANER

The most advanced safe and effective chemical cleaning technology available in today's market for Oil Boiler Cleaning and servicing.

Dualx saves time and effort, on average this cleaning agent could save a servicing engineer about 6 hours in a normal working week.

Condensing and non-Condensing Oil Fired Boiler Cleaning Agent.

Twin Pack
Powder & Spray



No: **DUALXBLRCLN**



LD90 LEAK DETECTION SPRAY

400 ml

No: **1930**



LEAK DETECTION GEL

250 ml

No: **1998**



AC90 MAINTENANCE SPRAY

425 ml

No: **2006**



AIR DUSTER

150 ml

No: **REG-Z05**



SPRAY ADHESIVE

500ml

No: **AMBERNC500**



REGIN WATER DETECTING PASTE

Water Finding Paste
for Oil - 3oz

No: **REG-003**



ROCOL OIL SEAL

300g
Thixotropic hard
setting for pressure
tight seals.

No: **28032**



BRIGON CO² FLUID

Red

No: **BG2603003-1**



STAG "B" JOINTING PASTE

500g Tin

No: **REDB500**



HELDITE JOINTING COMPOUND

250mm C/W Brush
No: **HELD250**

500g Paste
No: **HELD-CAN500**



HEATBOND FIXING COMPOUND

Stove Rope Fixative
125ml Bottle



No: **HY201610**

CERAMIC ROPE

Available in
braided or soft.
From 6mm to 25mm



No: **CERROPE**

STOVE ROPE ADHESIVE

Heat Resistant 850°C
30ml Bottle



No: **REG-Y25**

HIGH TEMPERATURE SEALANT

White No: **REG-Z35**
Clear No: **REG-Z36**
Black No: **REG-Z37**



CERAMIC BOARD (1M²)

10mm No: **CERABOARD10**
20mm No: **CERABOARD20**

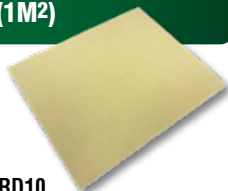

FIRE CEMENT

Black
2Kg No: **CG602122B**
Gray
2Kg No: **CG602122**
5Kg No: **CG602123**



FLUE 'N' FIRE SEAL

Silicate Cement
150ml
Heat Resistant 1500°C



No: **REG-Z32**

SMOKE PELLETS

Burn time
30 seconds



Pack of 10 **REG-S15**
Tub of 100 **REG-S20**

SMOKE MATCHES

12 per box
(approx)



No: **REG-S05**

BOILER CLEANER

EXPEL "C" Boiler
Cleaning Chemical



No: **2199998**

1 LITRE CHEMICAL RANGE

Description	No
Inhibitor X100	X100
Noise Reducer X200	X200
System Cleanser X300	X300
System Restorer X400	X400
Inhibited Antifreeze X500	X500
Underfloor Biocide X700	X700
Jetflo Heavy Duty Cleaner X800	X800

RAPID DOSE

Description	No
X100 Rapid Dose 400ml	X100RD
X200 Rapid Dose 400ml	X200RD
X400 Rapid Dose 400ml	X400RD
Rapid Dose Leak Sealer	RD-LS
Rapid Dose filling loop adaptor	RD-FLA
Rapid Dose radiator adaptor	RD-RA
Rapid Dose tool kit	RD-TK

500ML CHEMICAL RANGE

Description	No
Protector F1	56599
Boiler noise silencer F2	56602
Cleaner F3	56600
Leak sealer F4	56603

RAPID DOSE

Description	No
Protector F1 Express, 265ml	58229
Boiler noise silencer F2 Express, 265ml	58231
Leak sealer F4 Express, 265ml	58232
Cleaner F5 Express, 280ml	58230

MAGNACLEAN PROFESSIONAL 2

2 Year Manufacturer's Guarantee

 28mm No: **FL1-03-01357**

 22mm No: **CP1-03-00022-01**

MAGNACLEAN MICRO 2

 No: **FL1-03-01274**
MAGNACLEAN TWIN TECH

 No: **MCTT001**
FERNOX TF1 FILTER

 22mm No: **59256**

 28mm No: **59257**
GRANT MAG ONE

 No: **GTVM01**
ADEY CHEMICAL RANGE

Description

MC1 Protector 500ml

MC2 Silencer 500ml

MC3 Cleaner 500ml

MC4 Leak Sealer 500ml

MC5 Rapid Flush 500ml



No

CH1-03-01669
CP1-03-00994
CH1-03-01670
CP1-03-00998
CP1-03-00999
ADEY RAPIDE

Description

MC1 Rapide Dose 300ml

MC2 Rapide Dose 300ml

MC3 Rapide Dose 300ml

MC4 Rapide Dose 300ml

MC10 Rapide Dose 300ml



No

CH1-03-01640
CH1-03-02038
CH1-03-01645
CH1-03-02039
CH1-03-02040

WIRELESS INTERLINK SMOKE ALARM & THERMOPTEK MULTI-SENSOR SMOKE ALARM

WST-630T

- Thermoptek Multi-Sensor technology
- Wi-Safe 2 technology
- 10 year sealed for life lithium battery
- Large central button - Test / Smart Silence / Locate
- Locate feature
- Smart Silence
- Sleep Easy



Wi-Safe 2

ST-622T

- Thermoptek Multi-Sensor technology
- 10 year sealed for life lithium battery
- Large central button
- Easy installation
- Smart Silence
- Sleep Easy
- Used and endorsed by UK Fire and Rescue Services



WIRELESS CLASS A1 HEAT ALARM AND CLASS A1 HEAT ALARM

WHT-630T

- Thermistek technology, incorporating a unique radiant heat dish
- Wi-Safe 2 technology
- Class A1 heat alarm
- 10 year sealed for life lithium battery
- Large central button - Test / Smart Silence / Locate
- Locate function
- Smart Silence



Wi-Safe 2

HT-630T

- Thermistek technology, incorporating a unique radiant heat dish
- Class A1 heat alarm
- 10 year sealed for life lithium battery
- Large central button - Test / Smart Silence
- Smart Silence



7 YEAR CO ALARM

CO-9XT-FF

- Advanced electrochemical sensor - calibrated and tested in CO gas
- 7 year sealed for life lithium battery
- Alarm can be free-standing or wall mounted
- Supplied with tamper resistant Fast-Fit bracket with single pin or 2 screw fitting options
- Test button and LED status indicators



COLD ALARM

CDA-9X

- Cold alarm provides an early warning before the room temperature falls to a dangerously low level.
- Easy to install
 - Completely portable
 - A series of visual and audible warnings when the temperature drops
 - Large easy press test and silence button
 - Sealed alarm with internal power pack lasting 10 years



10 YEAR CO ALARM

CO-9X-10T-FF

- Advanced electrochemical sensor - calibrated and tested in CO gas
- 10 year sealed for life lithium battery
- Alarm can be free-standing or wall mounted
- Supplied with tamper resistant Fast-Fit bracket with single pin or 2 screw fitting options
- Test button and LED status indicators



REPLACEABLE BATTERY CO ALARM

CO-9D

- Test/Reset button for weekly alarm testing
- Powered by 2 x AA alkaline batteries
- 7 year warranty
- BS EN 50291:2001



PLUS POWER



Description	Per Pack	No
AA SIZE	4	DCAA4
AAA SIZE	4	DCAAAX4
C SIZE	2	DCCX2
D SIZE	2	DCDX2
9V SIZE	1	DC9VX1

WORKMATE TORCH

Handheld torch
c/w 6V Battery
(Replacement
battery EC009)



No: **EC011**

TORCH BATTERY

6 Volt



No: **EC009**

ENGINEERS ELECTRIC LEAD LIGHT

5 metre cable & 13A
plug fitted to both

240 volt

No: **010816113**

110 volt

No: **010816123**



VOLT SENSOR

Regin



No: **REG-T15**

CONNECTOR BLOCKS



5 amp No: **EC5CON**

15 amp No: **EC15CON**

240V FUSES

Pack of 10



3 amp No: **EC007**

5 amp No: **EC006**

13 amp No: **EC005**

OIL PRESSURE GAUGE 300PSI

0-300 PSI. 1/8" BSP
General Purpose
20 Bar



No: **1703001**

OIL PRESSURE GAUGE 300PSI

0-300 PSI 1/8" BSP
Glycerine Filled.
High Accuracy
20 bar



No: **1704001**

PRESSURE GAUGE TEST TEE

Oil Pump Testing
Tee 1/8 inch



No: **1703000**

HIGH PRESSURE GAUGE HOSE

Used to connect Gauge
to Test Tee

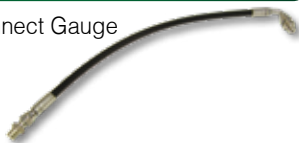

No: **FOL100**

PRESSURE GAUGE EXTENSION

1/8" BSP
80mm long



No: **3008876**

OIL PRESSURE TEST KIT

C/W Case,
2x gauges, test tee,
H.P hose, &
connecting nipples



No: **1704100**

OIL SUCTION PUMP

Used to prime
oil lines



Pump No: **3006035**
Replacement Seal Kit No: **3006036**

OIL MEASURING CYLINDER

Pyrex 50ml Glass
Measuring Cylinder



No: **CYG030030**

OIL VAPOURISING TEST KIT



For installing Vapourising Burner/Range
Cookers

- Bi-Directional Spirit Level
- Pyrex Measuring Cylinder
- Steel Rule

Supplied in foam cased plastic carry case

No: **6236**

OIL EXTRACTOR UNIT

2.7ltr Vessel

Ideal for emptying drip trays, tank cabinets, bunds or sucking up fuel spills.

Can be used to prime oil lines.

Can also be used with water.

No: **3008100**

OIL TANK WATER EXTRACTOR UNIT

6ltr Vessel

Bi-directional

(Pump or Suction)

No: **3008101**

GOK OIL LINE PRESSURE TEST KIT

Hand Pump

Pressure gauge to 6 bar

Includes connecting

hose & carry case.

No: **3006037**

SMOKE PUMP

Kane Smoke Pump

Papers and case

included

No: **KAMSP**

BRIGON SMOKE PAPERS

Pack of 40

Smoke Papers

No: **BG2602008**

DRAUGHT GAUGE

No: **BG2601003**

FAN PULLER

No: **REG-T25**

FLARING TOOL

Metric

Standard 45 Degree

(4.75 - 10mm)

No: **REG-0100**

THERMOCOUPLE TESTER

Regin

No: **REG-T20**



WIND-UP HEAD TORCH

3x LED



No: 40407

WIND-UP TORCH

3x LED



No: 42989

TRIMMING KNIFE

Easy Find
Retractable



No: 75285

5 METRE MEASURING TAPE

5m/16ft
Value Soft Grip
Metric/Imperial



No: 09229

30 PIECE HEXAGONAL KEY SET

30 piece Metric/Imperial
Combined Long Pattern
Hexagon Key Set



No: 36000

HEXAGONAL KEY TOOL

8 piece
Metric Hexagon
Key Tool/Set



No: 73070

8 PIECE SCREWDRIVER SET

8x Piece
Cabinet Pattern
Screwdriver Set



No: 14077

4 PIECE VDE SCREWDRIVER SET

4x Piece
VDE Approved
Fully Insulated



No: 07495

7 PIECE VDE SCREWDRIVER SET

7x Piece
VDE Approved
Fully insulated
c/w Mains Tester



No: 07496

11 PIECE SCREWDRIVER SET

11x Piece
VDE Approved
Fully Insulated



No: 69234

MOLEGRIPS SET

3x Piece
Curved Jaw
Self grip pliers



No: 14040

KNIPEX WATER PUMP PLIERS

Fully Insulated 250mm
Alligator - Water Pump Pliers



No: 32013

ADJUSTABLE WRENCH SET

3x Piece
Soft Grip
Adjustable
Wrench Set



No: 88598

3 PIECE VDE PLIERS SET

3x Piece
VDE Approved
Fully Insulated
Slimline Pliers Set



No: 49157

4 PIECE FILE SET

4x Piece
200mm Soft Grip
Engineers File Set



No: 44962

12 PIECE SPANNER SET

12x Piece
Expert Hi-Torque
Metric Combination
Spanner Set



No: 64605

COMPARTMENT ORGANISER

5 to 26
Compartment
Organiser



No: 73508

TOOLBOX / ORGANISER

Toolbox with
tote tray



No: 11497

TOOL BOX

Large
Tool Box



No: 27732

DIGITAL MULTIMETER

Protective case,
Battery Included



No: 60792



Multi Fuel Combustion Analyser

- Easy to use rotary switch
- Measures O₂, CO and temperature
- Calculates CO₂, CO/CO₂ ratio and excess air
- Calculates Nett, Gross and condensing boiler efficiency
- Multi fuel – Natural Gas, Propane, Butane, LPG, Light Oils (28/35 sec) and Wood Pellets



Kit Options	Analyser, flue probe, batteries, manual, calibration report	Infra-red printer, (KMIRP)	Carry case	NIMH rechargeable batteries and charger	KANE MSP Smoke Pump	0-300psi pressure gauge & pressure gauge manifold	Compound gauge (pressure and vacuum)	High pressure hose & 2 x adaptors
KANE250	✓							
KANE250 Kit	✓	✓	✓	✓				
KANE250 Oil Kit	✓	✓	✓	✓	✓	✓	✓	✓

Low annual service costs and 5 year extended warranty when serviced annually by Kane

Kane International reserves the right to make changes to products & specifications without prior notice. E & OE.
 © The KANE logo is a registered trademark of Kane International Ltd



709R Kit Options

TPI 709R Flue Gas Analyser Kit

- **Combustion Efficiency Analyser:**
Measure O₂, CO, and flue temperature.
Calculate efficiency, excess air, CO₂ & (CO/CO₂) Ratio.
- **CO Analyser:**
Measure carbon monoxide in ambient air.
- **Differential Manometer:**
+/- 150 mBar
(0.01 mBar resolution)
Great for Tightness/Let By or Burner Pressure Testing
- **Differential Thermometer:**
Dual input K-Type thermocouple thermometer measures differential temperatures
Ideal for Measuring & Recording Flow & Return Temperatures



Kit options available

Kit 1 add a TPI A740 IR Printer



Kit 2 add a Printer & 2 x CK21M Pipe Clamps



Kit 3 add an IR Printer, 2 x Pipe Clamps & CPA1 Probe Kit



Kit 4 add an IR Printer, 2 x Pipe Clamps & TPI 719 Gas Sniffer



Kit 5 add an IR Printer, 2 x Temp. Pipe Clamps, CPA1 Probe Kit & TPI 719 Gas Sniffer



Kit 1 OIL add an IR Printer, Smoke Pump & Oil Filter





SPRINT PRO MODELS & KIT OPTIONS

Pro1



Pro1 Kit



Pro2



Pro2 KitA



Pro2 KitB



Pro3



Pro3 KitA



Pro3 KitB



Sprint Pro4, 5 & 6 analysers and kits supplied with accessories as shown in Pro3 images above

SPRINT PRO ACCESSORIES & SPARES

Pro Printer - USB



C03743

Pro Standard Flue Probe



C03738

Pro Bent Flue Probe



C03738-B

Pro Gas Escape Probe



C03737

Pro Drop In Bag



C03740

Hard Carry Case



HCC/1

Pro BS7967 Probe Set



Pro BS7967

Pressure Relief Valve



APRV

USB-C Charger / Comms Lead



E01378

USB Charger Adaptor



E01377

Pro Depth Gauge



M03876

Printer Rechargeable Batteries



476-2033 4 pack

1m Air Probe



GK11M

Pro Flue Probe Connector



M04202

Personal CO Alarm



Clip CO

CO Tripod Stand



ACMT

Liquid Binder Probe



AA15/HDH

Surface Temp Probe



AS1/HDH

Pipe Temp Probe



AS10/clamp

Oil smoke pump & Oil commissioning kits available

All prices exclude VAT & carriage charges where applicable



ABGO

www.abgo.co.uk



Follow us on Social Media

ABGO

**Unit 1 Sidings Close,
Wednesfield Road,
Bentley Bridge Business Park,
Wolverhampton WV11 3DR**

Tel: (01902) 790 900

Fax: (01902) 790 909

Text: 07917 772582

Email: sales@abgo.co.uk



Edition OB4.3